

Align template to rear edge of recess

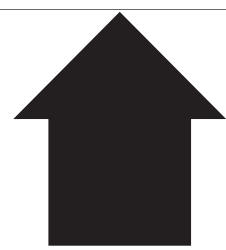

Align template to rear edge of recess



### SK03 STACK KIT MOUNTING INSTRUCTIONS AND PATTERN

FOR USE WITH DV6400X OR DV6500X 110V ELECTRIC DRYER & WFL1300XD FRONT-LOADING WASHER

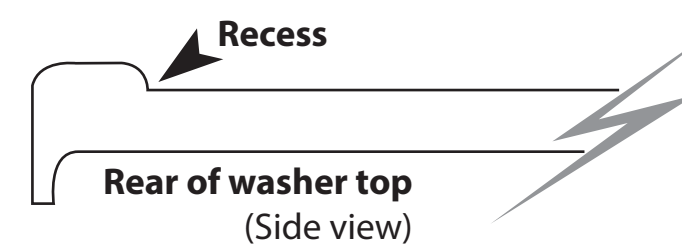
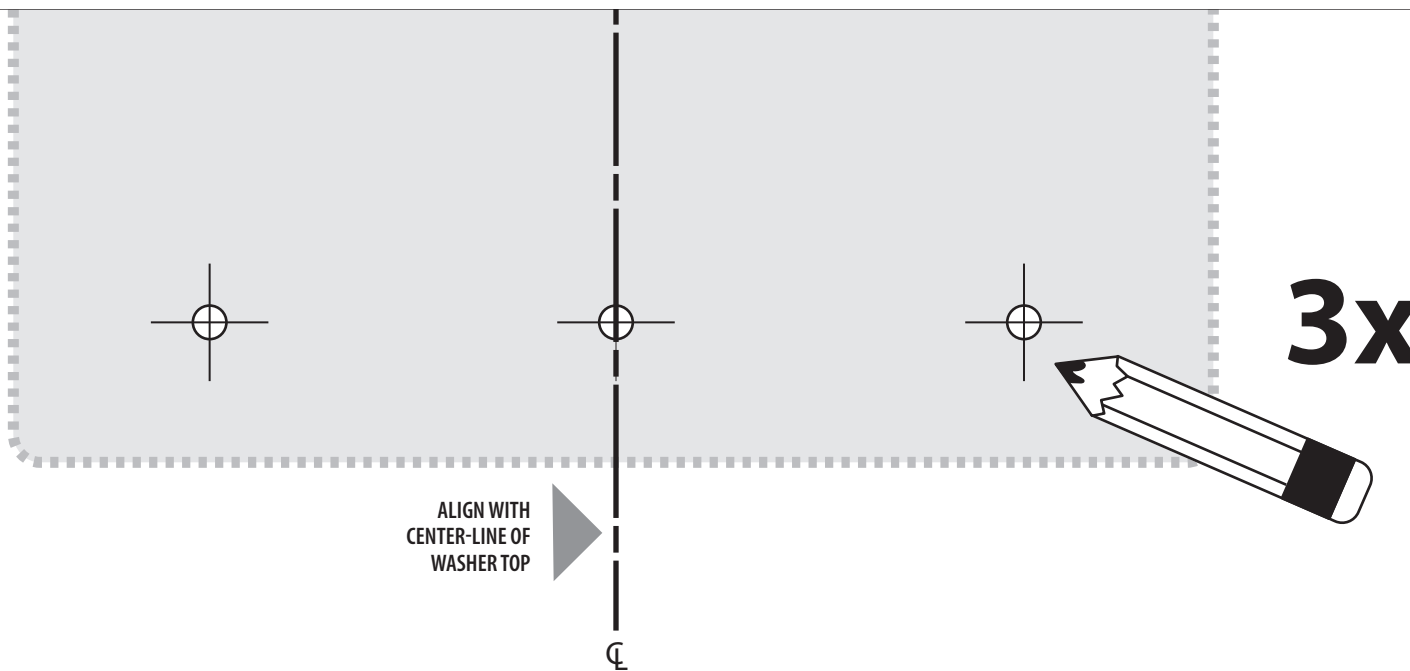

1x **C**

1x **E** **F**

1x **E** **G**

7x **D** **D**

3x **F** **DRILL BIT NOT INCLUDED**

SIZE 3/32"

**DV6400X or DV6500X Dryer**

**WFL1300XD Washer**

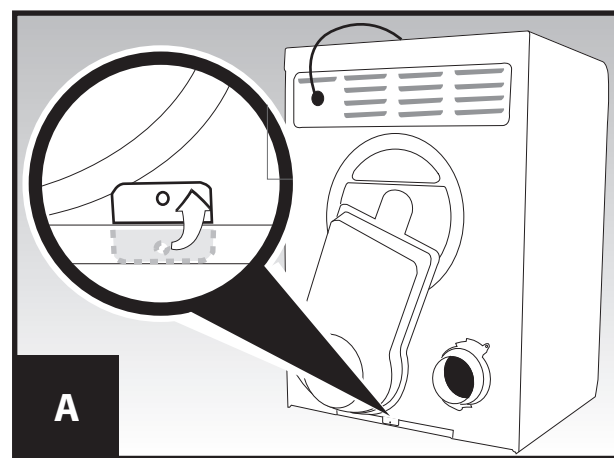

**A** Bend tab up so rear bracket can be inserted later

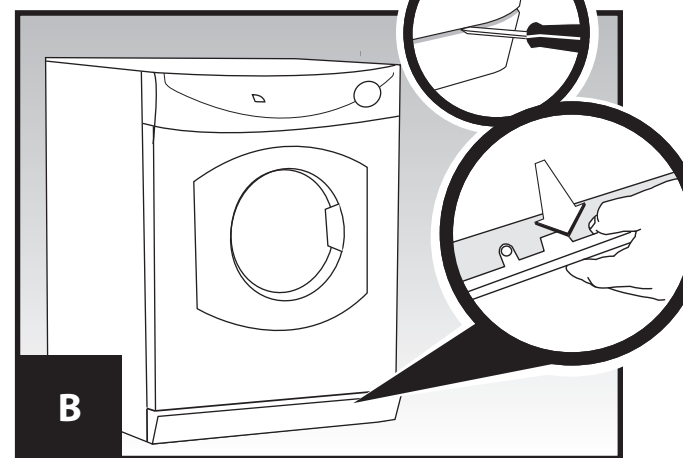

**B** Remove dryer kick-plate

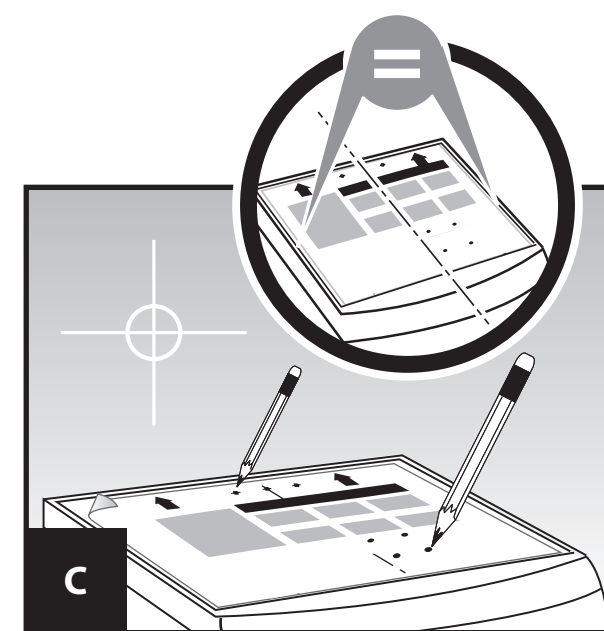

**C** Use pattern to mark drill hole positions on washer top

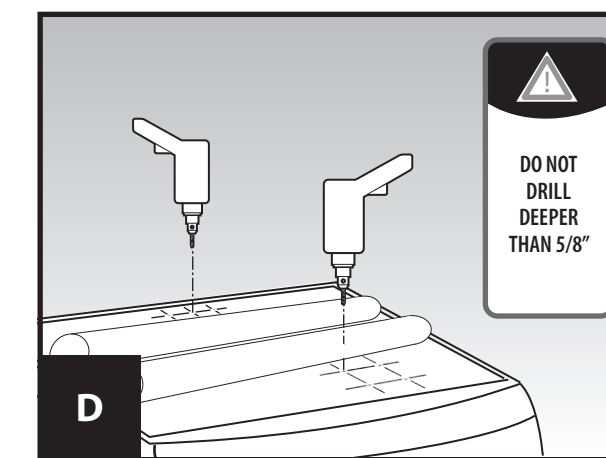

**D** Drill holes into washer top

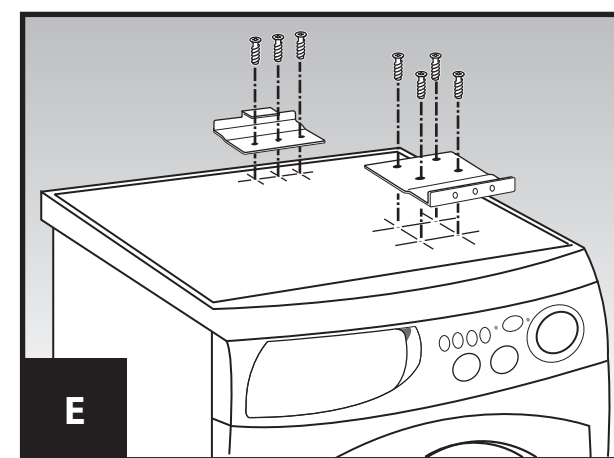

**E** Secure brackets to washer top

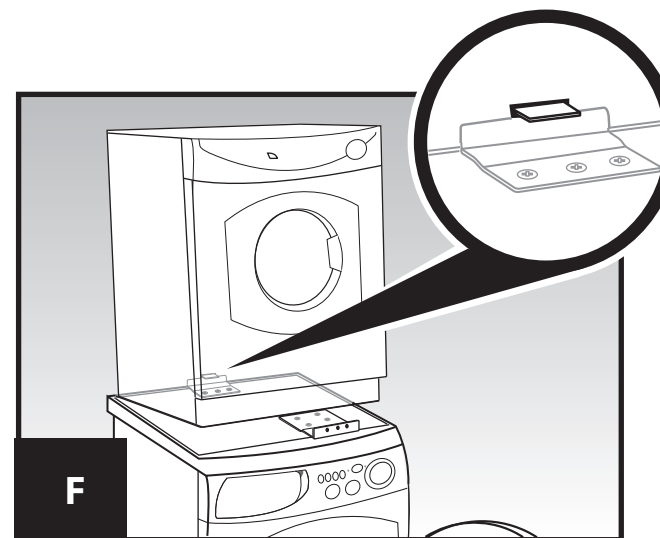

**F** Insert rear bracket into dryer

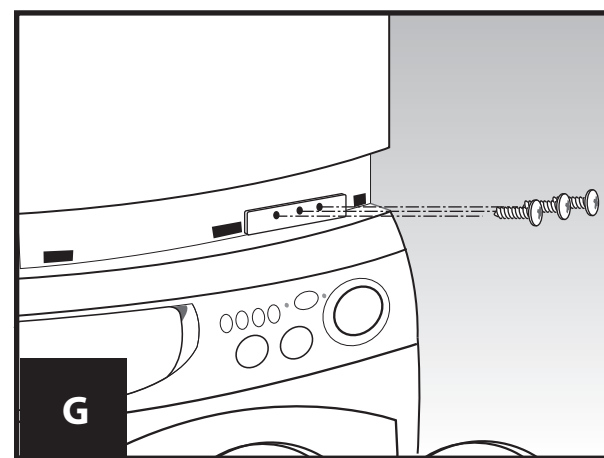

**G** Secure front bracket to dryer

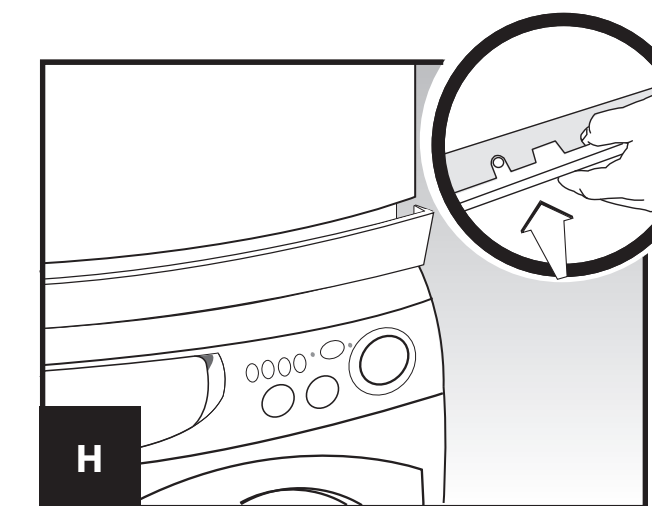

**H** Reinstall dryer kick-plate

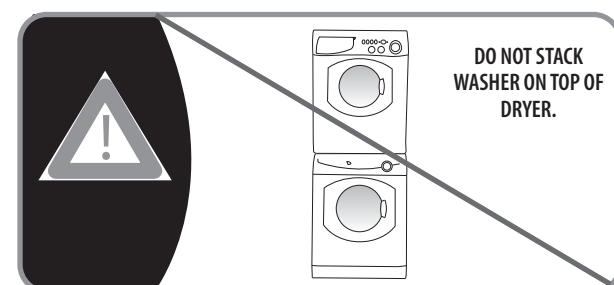
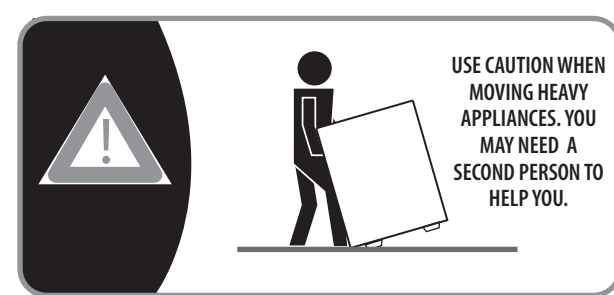

4x

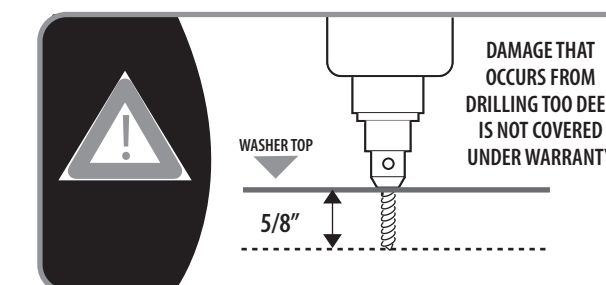
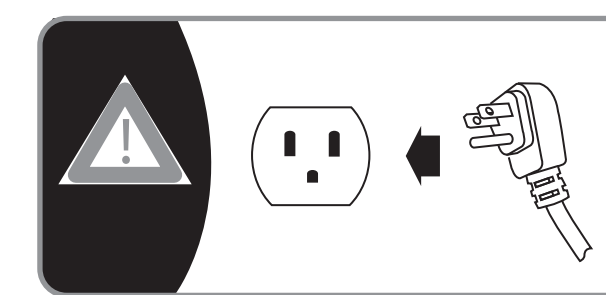
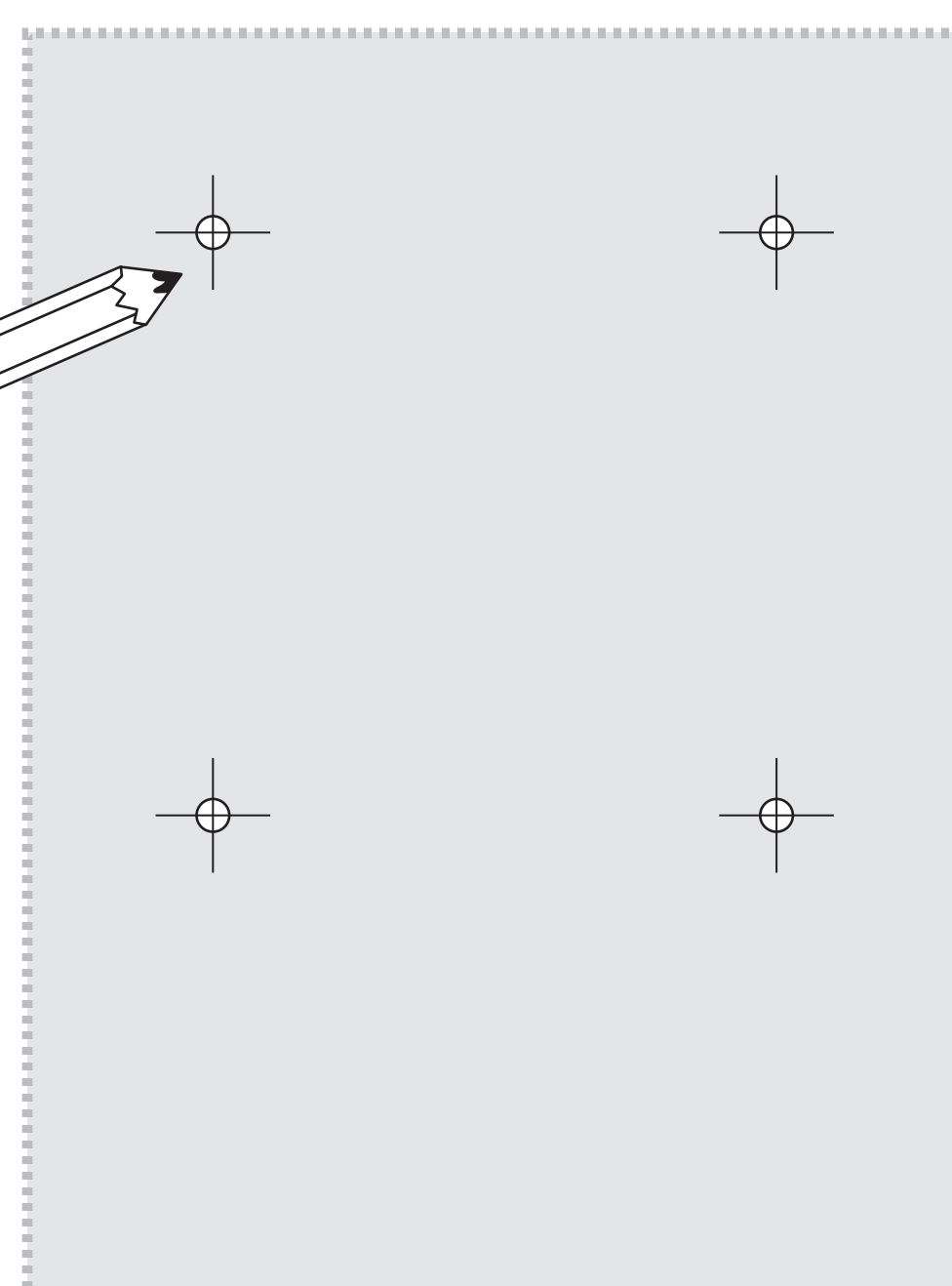

USE ONLY SCREWS FROM KIT