

Care, Use and Installation booklet

TUMBLE DRYER

EN

English 1

AS66VX

Contents

Warnings and Safety Instructions, 2

- Important safety instructions
- Grounding instructions

Dryer Description, 3

- The front
- The back
- Control panel

Start and Programs, 4-5

- Choosing a program
- Table of programs

Laundry, 6-7

- Sorting your laundry
- Wash care labels
- Special clothing items
- Drying times

Maintenance and Care, 8

- When to switch off the electricity
- Clean the filter after each cycle
- Check the drum after each cycle
- Cleaning the dryer

Troubleshooting, 9

- Spare parts

Installation, 10-11

- Electrical
- Where to put your dryer
- Exhaust ducting
- Stacking kit



Warnings and Safety Instructions

SAVE THESE INSTRUCTIONS

EN

! The appliance has been designed and built according to international safety standards. These warnings are given for safety reasons and must be read carefully.

Important safety instructions

WARNING:

To reduce the risk of fire, electric shock or injury to persons when using your appliance, follow the basic precautions, including the following:

- Read all instructions before using the appliance.
- Do not dry articles that have been previously cleaned in, washed in, soaked in, or spotted with gasoline, dry-cleaning solvents or other flammable or explosive substances, as they give off vapours that could ignite or explode.
- Do not allow children to play on or in the appliance. Close supervision of children is necessary when the appliance is used near children.
- Before the appliance is removed from service or discarded, remove the door to the drying compartment.
- Do not reach into the appliance if the drum is moving.
- Do not install or store this appliance where it will be exposed to the weather.
- Do not tamper with the controls.
- Do not repair or replace any part of the appliance or attempt any servicing unless specifically recommended in the user-maintenance instructions.
- Do not use fabric softeners or products to eliminate static unless recommended by the manufacturer of the fabric softener or product.
- Do not use heat to dry articles containing foam rubber or similarly textured rubber-like materials.
- Clean the lint filter before and after each load (*see Maintenance*).
- Keep the area around the exhaust opening and adjacent surroundings free from the accumulation of lint, dust and dirt.
- The interior of the appliance and exhaust duct should be cleaned periodically by qualified service personnel.
- Do not place items exposed to cooking oils in your dryer. Items contaminated with cooking oils may contribute to a chemical reaction that could cause a load to catch fire.
- This tumble dryer has been designed for home, and not professional, use.
- This dryer must be used by adults, and the instructions in this booklet should be followed carefully.
- Do not touch the appliance while barefoot or with wet hands or feet.
- The appliance must be installed correctly and have proper ventilation. The air intake vents behind the machine, the outlet vents should never be obstructed (*see Installation*).
- Check to see if the dryer is empty before loading it.
-  The back of the dryer could become very hot. Never touch it while in use.

- Do not use the dryer unless the filter is securely in place (*see Maintenance*).
- Do not overload the dryer (*see Laundry* for maximum loads).
- Do not load items that are dripping wet.
- Tumble dry items only if they have been washed with detergent and water, rinsed and been through the spin cycle. It is a fire hazard to dry items that have not been washed with water.
- Carefully check all instructions on clothing labels (*see Laundry*).
- Do not tumble dry large, very bulky items.
- Do not tumble dry acrylic fibres at high temperatures.
- Complete each program with its Air Fluff phase.

- Never climb on top of the dryer. It could result in damage.
- Comply with specified electrical requirements (*see Installation*).
- Always buy original spare parts and accessories (*see Troubleshooting*).

Grounding instructions (*see installation*)

WARNING:

THIS APPLIANCE MUST BE GROUNDED.

Improper connection of the equipment-grounding conductor can result in a risk of electric shock. Check with a qualified electrician or service representative or personnel if you are in doubt as to whether the appliance is properly grounded!

In the event of malfunction or breakdown, grounding will reduce the risk of electric shock by providing a path of least resistance for electric current. This appliance is equipped with a cord having an equipment-grounding conductor and a grounding plug. The plug must be plugged into an appropriate outlet that is properly installed and grounded in accordance with all local codes and ordinances.

DO NOT modify the plug provided with the appliance: if it will not fit the outlet, have a proper outlet installed by a qualified electrician or exchange the cord with an appropriate one rated for the dryer.

REFER TO THE RATING PLATE FOR VOLTAGE AND CURRENT REQUIREMENTS (*see diagram for location*).

The dryer should be connected to the mains supply via a suitable socket which is **accessible** after installing your dryer. This dryer must be connected to 15A INDIVIDUAL BRANCH CIRCUIT.

For full details see Installation Instruction sections of this book.

IF IN DOUBT ABOUT ANY OF THE ABOVE CONSULT A QUALIFIED ELECTRICIAN

Dryer Description

EN

The front

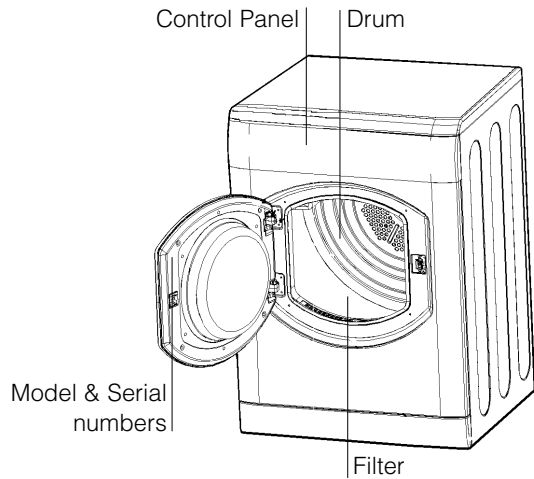

The back

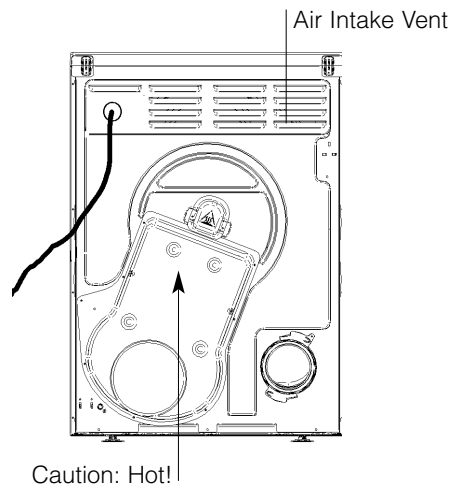

Control panel

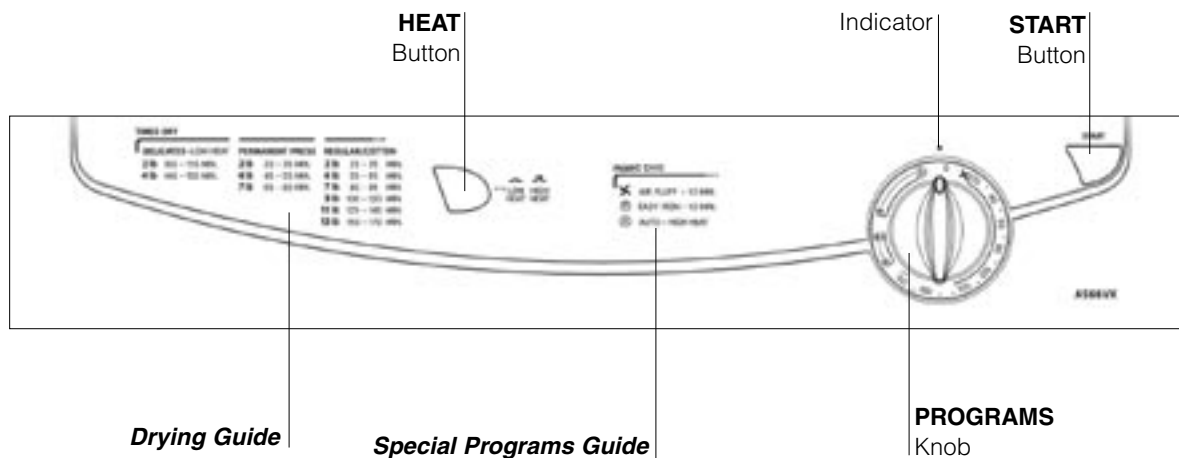

The **START** button begins drying a selected program (*see Start and Programs*).

The **HEAT** button selects drying temperature (*see Start and Programs*).

OUT: HIGH heat.
IN: LOW heat.

The **Drying Guide** allows you to consult a user friendly table of fabric types and load capacities.

The **Special Programs Guide** gives a guide to the available programs.

The **PROGRAMS** knob sets the program: rotate it clockwise, **never counter-clockwise**, until the indicator is pointing to the program you want to select (*see Start and Programs*). The programs knob will advance to the '0' position after the program ends.

Start and Programs



EN

Choosing a program

1. Plug the dryer into the electrical socket.
2. Sort your laundry according to fabric type (*see Laundry*).
3. Open the door and make sure the filter is clean and in place (*see Maintenance*).
4. Load the machine and make sure that the items are not in the way of the door seal. Close the door.
5. Choose the drying program by checking the Programs table (*see Programs*) as well as the indications for each type of fabric (*see Laundry*).
 - Set the temperature with the HEAT button.
 - Select a program or drying time by rotating the PROGRAMS knob clockwise.
6. Press the START button to begin.
During the drying program, you can check on your laundry and take out items that are dry while others continue drying. When you close the door again, press START in order to resume drying.
7. About 10 minutes before the program is completed, it enters the final AIR FLUFF phase (fabrics are cooled), which should always be allowed to complete.
8. Open the door, take your laundry out, clean the filter and replace it (*see Maintenance*).
9. Unplug the dryer.

Programs

EN

<i>Program</i>	<i>What it does...</i>	<i>How to set it...</i>	<i>Note:</i>
Timed Drying up to 170 minutes	Dries wet clothing	<ol style="list-style-type: none"> 1. Select required heat setting HIGH HEAT or LOW HEAT by pressing the HEAT button. 2. Position the PROGRAMS knob on the desired time. 3. Press the START button. 	Consult suggested drying times (<i>see Laundry</i>).
Fabric Care  Air Fluff Phase	Heating elements turn themselves off and clothing is cooled down.	This is the final phase of all programs. Approximately 10 minutes before the finish, the knob advances automatically to the Air Fluff phase. After this the clothing is ready to be taken out.	Always allow the dryer to complete this phase.
Fabric Care  Easy Iron	Brief program (approximately 10 minutes) that softens fibers of clothing that is ready for ironing.	<ol style="list-style-type: none"> 1. Select HIGH HEAT by pressing the HEAT button. 2. Position the PROGRAMS knob on . 3. Press the START button. 	! This is not a drying program (<i>see below</i>).
Fabric Care A Automatic Drying	Dries completely: your clothes are ready to be worn. Regular Cottons, Permanent Press.	<ol style="list-style-type: none"> 1. Select HIGH HEAT by pressing the HEAT button. 2. Position the PROGRAMS knob on A. 3. Press the START button. 	! If you select LOW HEAT, this program will not dry your clothes. For Acrylic fibers or small loads select Timed Drying.

Easy Iron Program

Easy Iron is a short 10 minute programme (8 minutes of heat followed by a 2 minute Air Fluff period) which fluffs the fibers of clothing that have been left in the same position/location for an extended period of time. The cycle relaxes the fibers and makes them easier to iron and fold.

! Easy Iron is **not a drying program**

For best results:

1. Do not load more than the maximum capacity.

These numbers refer to the dry weight:

Fabric	Maximum load
Regular Cotton and Regular Cotton mix	5.5 lb / 2.5 kg
Permanent Press	4 lb / 2 kg
Denim	4 lb / 2 kg

2. Unload the dryer immediately after the end of the program, hang, fold or iron the articles and put them away. Should this not be possible, repeat the program.

The Easy Iron effect varies from one fabric to the next. It works very well on traditional fabrics like Regular Cottons or Regular Cotton mix, and less well on acrylic fibers.

Laundry

EN

Sorting your laundry

- Check symbols on clothing labels to make sure that the articles can be tumble dried.
- Sort laundry by fabric type.
- Empty pockets and check buttons.
- Close zippers and hooks and tie loose belts and strings.
- Wring out each item in order to eliminate as much excess water as possible.

! Do not load dripping wet clothes into the dryer.

Maximum load size

Do not load more than maximum capacity.

These numbers refer to dry weight:

Natural fibres: 6 kg max (13 lb)

Synthetic fibres: 3 kg max (6.6 lb)

! DO NOT overload the dryer as this could result in reduced drying performance.

Typical weights





Clothes			
Blouse	Cotton	150 g	5 oz
	Other	100 g	3 oz
Dress	Cotton	500 g	1 lb 2 oz
	Other	350 g	12 oz
Jeans		700 g	1 lb 6 oz
10 Diapers		1000 g	2 lb 3 oz
Shirt	Cotton	300 g	10 oz
	Other	200 g	7 oz
T-Shirt		125 g	4 oz

Household Items			
Duvet cover (Double)	Cotton	1500 g	3 lb 5 oz
	Other	1000 g	2 lb 3 oz
Large Tablecloth		700 g	1 lb 6 oz
Small Tablecloth		250 g	9 oz
Tea Towel		100 g	3 oz
Bath Towel		700 g	1 lb 6 oz
Hand Towel		350 g	12 oz
Double Sheet		500 g	1 lb 2 oz
Single Sheet		350 g	12 oz

At the end of a drying cycle, cottons could still be damp if you grouped cottons and permanent press items together. If this happens simply give them an additional short period of drying.

Wash Care Labels

Look at the labels on your garments, especially when tumble drying for the first time. The following symbols are the most common:

-  May be tumble dried
-  Do **not** tumble dry
-  Tumble dry at high heat setting
-  Tumble dry at low heat setting

What not to tumble dry in your dryer:

- Articles that contain rubber or rubber-like materials or plastic film (pillows, cushions, or PVC rainwear), any other flammable objects or objects that contain flammable substances (towels soiled with hair spray).
- Glass fibres (certain types of draperies).
- Items which have been dry cleaned.
- Items with the ITCL Code (*see Special clothing items*) . These can be cleaned with special at-home dry cleaning products. Follow instructions carefully.
- Large bulky items (quilts, sleeping bags, pillows, cushions, large bedspreads etc). These expand when drying and would prevent airflow through the dryer.

Special clothing items

Blankets and Bedspreads: acrylic items (Acilan, Courtelle, Orion, Dralon) **must be dried** with special care on LOW heat setting. Avoid drying for a long period of time.

Pleated or creased garments: read the manufacturer's drying instructions on the garment.

Starched articles: do not dry these with non-starched items. Make sure that as much of the starch solution is removed from the load as possible before placing it in the dryer. Do not over-dry: the starch will become powdery and leave your clothing limp, which defeats the purpose of starch.

Drying times

The table below presents APPROXIMATE drying times in minutes. Weights refer to dry garments:

Regular Cottons					
High (full) Heat					
Drying times 800-1000rpm in washing machine					
		Half Load			Full Load
2 lb	4 lb	7 lb	9 lb	11 lb	13 lb
1 kg	2 kg	3 kg	4 kg	5 kg	6 kg
25-35	55-65	80-95	100-120	125-145	150-170
Permanent Press					
High (full) Heat					
Drying times on reduced spin in washing machine					
		Half Load		Full Load	
2 lb		4 lb		7 lb	
1 kg		2 kg		3 kg	
20-35		45-55		65-80	
Delicates/Acrylics					
Low (gentle) Heat					
Drying times on reduced spin in washing machine					
Half Load			Full Load		
2 lb			4 lb		
1 kg			2 kg		
100-115			140-150		

Times are approximate and can vary depending upon:

- Amount of water retained in clothes after spin cycle: towels and delicates retain a lot of water.
- Fabrics: items that are the same type of fabric but different textures and thicknesses may not have the same drying time.
- Quantity of laundry: single items or small loads may take longer to dry.
- Dryness: If you are going to iron some of your clothes, they can be taken out while still a bit damp. Others can be left longer if you need them to be completely dry.
- Heat setting.
- Room temperature: if the room where the dryer is located is cold, it will take longer for the dryer to dry your clothes.
- Bulk: some bulky items can be tumble dried with care. We suggest that you remove these items several times, shake them out, and return them to the dryer until finished.

! Do not over-dry your clothes. All fabrics contain a little natural moisture, which keeps them soft and fluffy.

Maintenance and Care

EN

When you should switch off the electricity

Unplug the dryer when not using it, when cleaning it and during maintenance activities.

Clean the filter after each cycle

The filter is an important part of your dryer: it accumulates lint and fluff that is formed while drying. Small items could also become trapped in the filter. When finished drying, therefore, clean the filter by rinsing it under running water or with your vacuum cleaner. Should the filter become clogged up, the airflow inside the dryer will be seriously compromised: drying times lengthen and you will consume more energy. It may also damage your dryer.

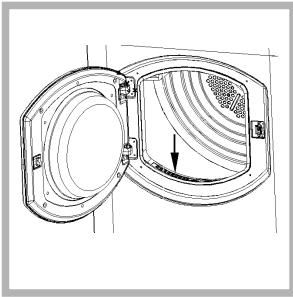

The filter is found in front of the dryer trim (*see diagram*).

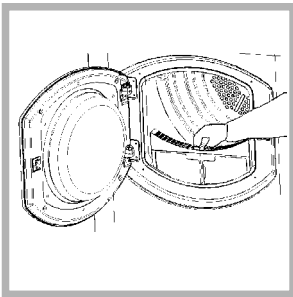

Removing the filter:
1. Pull the plastic grip of the filter upwards (*see diagram*).
2. Clean the filter and replace it correctly. Ensure the filter is fully located flush into the tumble dryer trim.

! Do not use the dryer without replacing the filter..

Check the drum after each cycle

Turn the drum manually in order to remove small items (handkerchiefs) that could have been left behind.

Cleaning the drum

! Do not use abrasives, steel wool or stainless steel cleaning agents to clean the drum.

A coloured film may start to appear on the stainless steel drum, this may be caused by a combination of water and, or cleaning agents such as fabric conditioner from the wash. This coloured film will not affect the dryer performance.

Cleaning the dryer

- External parts in metal or plastic and rubber parts can be cleaned with a damp cloth.
- Periodically check the vent tube and any permanent venting fixture to make sure that there has been no accumulation of fluff or lint, and remove it.
- Remove lint that collects around the filter and the outlet vents.

! Do not use solvents or abrasives.

! Your dryer uses special bearing components which do not need lubrication.

! Have your dryer checked regularly by authorized technicians to ensure electrical and mechanical safety.

Troubleshooting



Before you call our Customer Care Department, go through the following troubleshooting suggestions:

EN

Problem:

Possible causes / Solution:

The dryer won't start.

- The plug is not plugged into the socket, or not making contact.
- There has been a power outage.
- The fuse has blown.
- The door is not closed securely?
- The PROGRAMS knob has not been set properly (*see Start and Programs*).
- The START button has not been pressed (*see Start and Programs*).

Its taking a long time to dry.

- The filter has not been cleaned (*see Maintenance*).
- The temperature setting is not ideal for the type of fabric you are drying (*see Start and Programs, and see Laundry*).
- Automatic / Sensor Dry programs require a HIGH temperature setting (*see Start and Programs*).
- The correct program has not been selected for this load (*see Start and Programs, and see Laundry*).
- The exhaust duct is obstructed (*see Installation*).
- The air intake vent is obstructed (*see Installation*).
- The permanent ventilation flap on the storm cover is obstructed (*see Installation*).
- The items were too wet (*see Laundry*).
- The dryer was overloaded (*see Laundry*).

If you still have a problem, call our Customer Care Department at 1-800-356-0766

Spare Parts

This dryer is a complex machine. Repairing it yourself or having a non-authorized person try to repair it could cause harm to one or more persons and to the machine, and could invalidate the spare parts warranty. Call an authorized service center if you experience problems while using the machine.

Contact number: 1-800-356-0766

Installation Instructions

Read these instructions with care.

These instructions are provided for use by qualified installers, in addition the installation must comply with:

In the United States, in accordance with the National Electric Code ANSI/NFPA70 – latest edition and any State, Municipal or local codes.

Electrical

The dryer comes with a three cord power supply cord fitted with a 5-15P (plug), a receptacle should be installed in a location accessible after the dryer is installed.

Grounding

Some local codes may require a separate ground. In such cases the required ground wire, clamp and screw must be purchased separately.

NEVER ground the dryer to plastic plumbing lines, gas lines or water pipes.

**NOTE: IF IN DOUBT ABOUT ANY OF THE ABOVE
CONSULT A QUALIFIED ELECTRICIAN**

Where to put your dryer

Check local codes before choosing a location. Some codes do not permit installation in a garage, closet, mobile home or bedroom.. **DO NOT** install the dryer in an area where gasoline or other flammable materials are kept or stored.

When operating the dryer, there has to be adequate ventilation to avoid the back flow of gases into the room from appliances burning other fuels, including open fires.

Minimum installation clearances.

	Closet	Closet (alternative)	Under Counter
Sides	3/4" (15 mm)	0	3/4" (15 mm)
Top	1/2" (10 mm)	4" (100 mm)	1/2" (10 mm)
Rear	3/4" (15 mm)	3/4" (15 mm)	3/4" (15 mm)
Front	3/4" (15 mm)	3/4" (15 mm)	not applicable
Vent Opening – Distance from Top of closet	6" (150mm)	2" (50mm)	not applicable

If installed in a closet it must have the following dimensions and have two ventilation openings each having an area 72 sq. ins. (450 sq. cm) located 2" (50mm) or 6" (150mm) from top[see table] and 6" (150mm) from bottom of door.

It must NEVER be installed in a closet with a solid door.

The dryer has adjustable height feet, use these to level the dryer after fitting into its final position.

RV/Marine Installations - When locating the appliance in a towable trailer or watercraft, position the machine over the axles or mid-ship where movement is at a minimum. Block the machine to prevent extreme movement or tipping.

Exhaust ducting

The ducting system for the dryer must be as short and straight as possible and with as few elbows as possible. Four-inch rigid metal ducting should be used, metal flexible ducting can be used but the maximum length of ducting if using this type will be reduced and bends in the duct will reduce this length further. **Never** use plastic ducting. All elbows must also be a minimum of 4-inch (100mm) diameter. Joints must be secured with ducting tape. **Do not use** screws, as lint can collect on the screws.

Maximum Length of Duct:

Number of Elbows:	Rigid Duct	Flexible Duct
0	22 ft. (6.6m)	15 ft. (4.5m)
1	18 ft. (5.4m)	12 ft. (3.6m)
2	14 ft. (4.2m)	9 ft. (2.7m)
3	6 ft. (1.8m)	4 ft. (1.2m)

The above assumes that an approved venting hood is used and that the flap on this hood must **not** have magnetic catches.

WARNING:

- The appliance **MUST NOT** be exhausted into a chimney, a wall, a ceiling, or a concealed space of a building.
- To reduce the risk of fire, this appliance **MUST BE EXHAUSTED OUTDOORS.**
- Do not discharge the exhaust air into a flue, which is used for exhausting fumes from other appliances burning gas or other fuel.

Depending on the frequency of use it is essential that the ducting is checked periodically and any fluff or debris removed.

Stacking kit - Residential

The dryer is provided with a stacking kit, which allows the dryer to be fitted to the top of an Ariston washing machine:

Model AW121NA

The kit contains all the necessary brackets and screws.

Tools needed:

No.2 Philips Screwdriver

2mm drill, power or hand drill

SAFETY

For personal safety, DO NOT try to fit the dryer on top of the washing machine on your own. A second person should help to lift the tumble dryer onto the washing machine and to relocate the stacked washer and dryer.

1. You will need to get to the sides of the washing machine to fit the stacking kit and dryer. If necessary pull the machine away from its location to gain access to the machine to fit the stacking kit and dryer.
2. Follow the instructions provided with the stacking kit.

Stacking Kit - RV/Marine

RV/Marine Stacking Kit #SK02 available from Westland Sales: 1-800-356-0766.



© Copyright 2006, Westland Sales, Clackamas, OR 97015

1-800-356-0766

www.westlandsales.com