

Care, Use and Installation Booklet

FRONT-LOADING WASHER

EN
English

AW122

Contents

Warnings and Safety Instructions, 2

Important Safety Instructions

Washer Description, 3

The front, the back
Control panel

Start and Programs, 4-6

Choosing a Program
Table of control panel lights
Table of preset wash programs
Table of washing options

Dispenser, 7

Automatic dispenser drawer
Dispenser compartments
About using bleach
Table of laundry aids

Maintenance and Care, 8-9

When to switch off electricity and water faucets
After washing is complete
Clean the exterior, interior & dispenser drawer
Clear the coin trap
Check the rubber inlet hoses yearly
Winterization

Troubleshooting, 10-11

Spare parts

Technical Details, 12

Recessed, closet, alcove installations

Installation Requirements, 13-15

Tools and Parts
Location
Water Inlet Requirements
Drain System Requirements
Electrical Requirements

Installation Instructions, 16-17-18



Remove Transit Screws/Spacers
Connect the Inlet Hoses
Route and Secure the Drain Hose
Level the Washer
Final Installation Checklist

Warnings and Safety Instructions



The machine was designed and built in compliance with the appliance international safety regulations.
The information on this page is provided for your safety and should be read carefully.

WARNING!



To reduce the risk of fire, electrical shock, or injury to persons when using your appliance, follow basic precautions including the following:

 WARNING	
	ELECTRICAL SHOCK HAZARD
	Plug washer-dryer into a grounded 3 prong outlet.
	Do not remove ground prong.
	Do not use adapter.
	Do not use an extension cord.
Failure to follow these instructions can result in death, fire, or electrical shock.	

1. Read all instructions before using the appliance.
2. Do not wash articles that have been previously cleaned in, washed in, or spotted with gasoline, dry cleaning solvents, other flammable or explosive substances as they emit vapors that could ignite or explode.
3. Do not allow children to play on or in the appliance. Close supervision of children is necessary when the appliance is used near children.
4. Before the appliance is removed from service or discarded, remove the door.
5. Do not reach into the appliance if the tub or drum is moving.
6. Do not install or store this appliance where it will be exposed to the weather.
7. Do not tamper with controls.
8. Do not repair or replace any part of the appliance or attempt any servicing unless specifically recommended in the user-maintenance instructions or in published user-repair instructions that you understand or have the skills to carry out.
9. Do not add gasoline, dry-cleaning solvents, or other flammable or explosive substances to the wash water. These substances give off vapors, that could ignite or explode.

 WARNING	
	ELECTRICAL SHOCK HAZARD
	Disconnect power before servicing.
	Replace all panels before operating.
	Failure to do so can result in death or electrical shock.

10. Under certain conditions, Hydrogen gas may be produced in a hot water system that has not been used for 2 weeks or more. **HYDROGEN GAS IS EXPLOSIVE.** If the hot water system has not been used for such a period, before using a washing machine, turn on all hot water faucets and let the water flow from each for several minutes. This will release any accumulated Hydrogen.
11. Check the Coin Trap every few months to remove coins, buttons or similar size objects.
12. This appliance must be properly grounded (*see Grounding Instructions*).
13. Clothes, cleaning rags, mop heads and the like which have traces of any flammable substances, such as veg-

 WARNING	
	EXCESSIVE WEIGHT HAZARD
	Use two or more people to move and install the washer-dryer.
	Failure to do so can result in back or other injury

- etable oil, petroleum based oils or distillates, etc. must not be placed in the washing machine. These items may contain flammable substances after laundering which may smoke or catch fire by itself.
14. Always be sure to unplug the washing machine from the electrical supply before attempting any service.
 15. Do not insert/pull out the mains plug with wet hands.
 16. Do not pull out the mains plug by tugging the cable.
 17. Do not use an extension cord or an adapter to connect the washing machine to the electrical power supply.
 18. Caution when draining hot water.
 19. The washing machine must only be used for it's intended purpose.
 20. Make sure drum is empty before loading washer.
 21. Make sure that all water connections to the washing machine have shut-off valve(s) and that they are readily accessible. Close the washing machine shut-off valves at the end of each wash day.
 22. Check the fill hose connections on a regular basis to assure that they are tight and not leaking.
 23. Do not machine wash fiberglass materials. Small particles can stick to fabrics washed in following loads and cause skin irritation.
 24. Check the inlet hoses periodically for bulges, kinks, cuts, wear or leaks and replace them every five years.

Washer Description

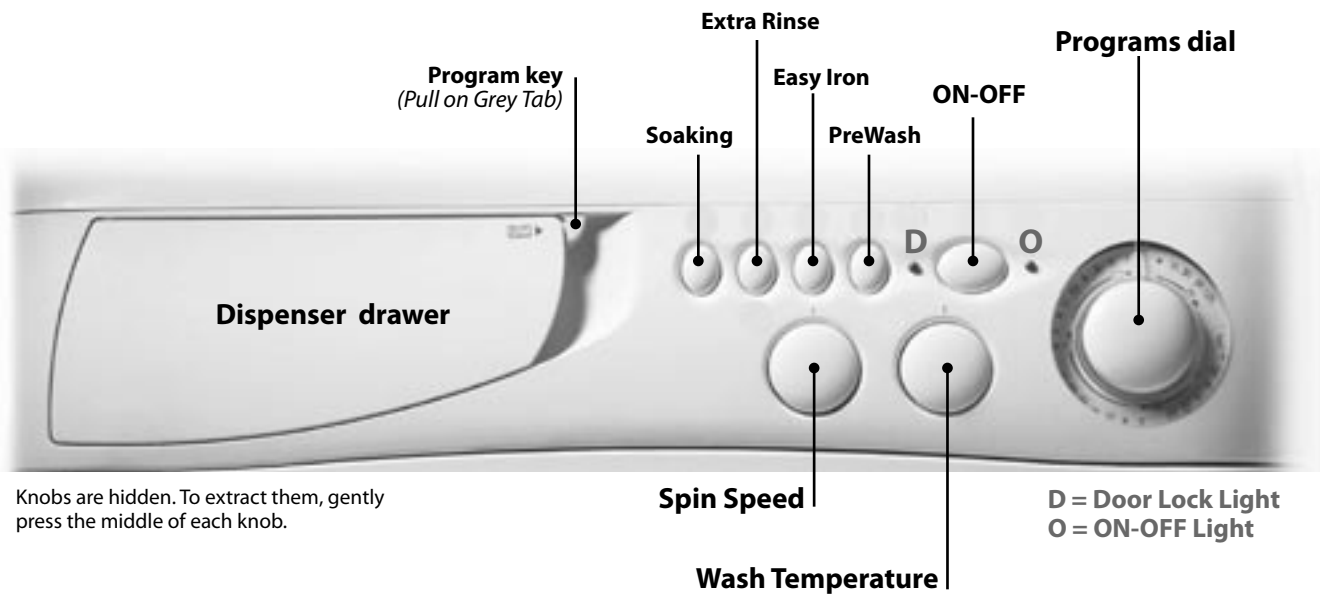
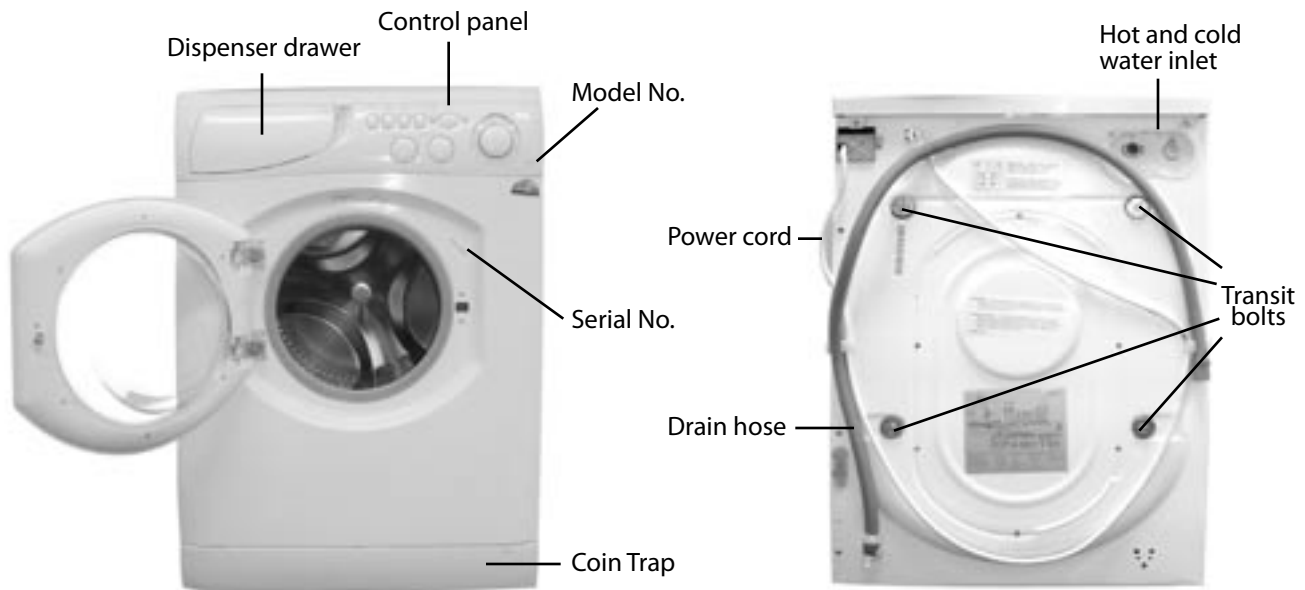

Introduction

Congratulations on the purchase of your new Ariston washing machine. It is a highly sophisticated engineered product that will give you many years of satisfaction. Please read this Owners Manual. It will show you ways to best utilize your valuable purchase.

Start and Programs

Choosing a program

1. Plug the washer into the electrical socket.
2. Sort your laundry according to similar colors, fabrics and degree of soil. For best results, do not load more than the maximum capacity:

Fabric	Maximum Load
Cottons	12 lbs.
Synthetics	6 lbs.
Delicate Fabrics	5 lbs.
Wools	3 lbs.
Bathrobes	5 lbs.

3. Open the door. Load the machine and make sure the items are not in the way of the door seal.
4. Close the door.
5. Choose the wash program by checking the Programs table (*see Preset Washing Programs*) as well as the fabric care tags found on your clothing.

- Select a washing cycle by rotating the **PROGRAMS** dial clockwise.
- Set the wash water temperature with the
- **TEMPERATURE** knob.
- Set the high spin speed with the

SPIN SPEED knob.

- To further customize the program, press one of the four **WASH OPTIONS** buttons (*see Washing Options*).

6. Open the dispenser drawer and add laundry aids (*see Dispenser drawer*).

Note: If your previous washing machine was a top-loader, initial loads may require little to no detergent. Old detergent trapped in the clothes will be released during the tumble action.

7. Close the dispenser drawer.
8. Press the **ON-OFF button** (in) to begin. During the washing program, you cannot open the door.
9. **When the cycle is complete, wait for the DOOR LOCK Light to extinguish.** Open the door and take your laundry out.
10. Unplug the washer.

Lights

Light	What it means...	Note
DOOR LOCK	Indicates when the door is locked	<ul style="list-style-type: none"> • The door will stay locked for up to 2 minutes after the program is completed • NEVER attempt to open the door when the DOOR LOCK light is ON
ON-OFF	Indicates the status of the washer	<ul style="list-style-type: none"> • This washer can perform self-diagnostics in the event of a problem. If needed, this light will indicate a fault code by displaying a specific series of blinking lights.

- **Light ON** = Locked
- **Light OFF** = Unlocked



- **Slow Flash** = Ready; awaiting instructions
- **Solid Light** = Program accepted; in operation
- **Quick Flash** = Program competed, but door still locked

Start and Programs



Preset washing programs

Program	Clothing Type	Description	High Spin	Recommendation
COTTON				
1 Sanitary	Colorfast Items	<ul style="list-style-type: none"> 120 minutes Heating element is used to reach 158°F wash temp. Bleach option not available 	1200 rpm	<ul style="list-style-type: none"> Eliminates harmful bacteria and safely deep cleans stained, cotton colorfast items The heating element will take about 10 minutes to reach full heat.
2 Heavy	Exceptionally soiled whites	<ul style="list-style-type: none"> 90 minutes 	1200 rpm	<ul style="list-style-type: none"> Sheets, tablecloths, etc.
3 Regular	Heavily soiled whites and colorfast colors	<ul style="list-style-type: none"> 50 minutes 	1200 rpm	<ul style="list-style-type: none"> Jeans, towels, etc. Fasten all hooks, zippers and buttons
4 Light	Slightly soiled whites and delicate colors	<ul style="list-style-type: none"> 40 minutes 	1200 rpm	<ul style="list-style-type: none"> Shirts, sweatshirts, etc. Turn printed shirts inside out before washing Tie all strings before loading
PERMANENT PRESS				
5 Heavy	Heavily soiled colorfast synthetics	<ul style="list-style-type: none"> 80 minutes 	800 rpm	<ul style="list-style-type: none"> Baby linen, etc.
6 Regular	Delicate color synthetics	<ul style="list-style-type: none"> 65 minutes 	800 rpm	<ul style="list-style-type: none"> All types of slightly soiled synthetics
7 Light	Delicate color synthetics	<ul style="list-style-type: none"> 40 minutes 	800 rpm	<ul style="list-style-type: none"> All types of slightly soiled synthetics
HAND WASHABLES				
8 Light	Delicate items	<ul style="list-style-type: none"> 64 minutes 	600 rpm	<ul style="list-style-type: none"> All types of delicate items Place underwear, tights stockings and other delicates in a linen bag
9 Silk	Particularly delicate items	<ul style="list-style-type: none"> 60 minutes 	No Spin	<ul style="list-style-type: none"> Curtains, silk, viscose
10 Wool	Wool hand washables	<ul style="list-style-type: none"> 65 minutes 	600 rpm	<ul style="list-style-type: none"> Wool scarf, sweater, etc. Turn knit items inside out Use very little detergent 3 lb. max load

Please Note: cycle times will vary according to size and fabric type of load, water system temperature and room temperature



- **DO NOT wash torn, frayed or non-hemmed items**
- **Empty all pockets before loading the laundry**

Symbols Key

● Stop/Reset	Spin Cycles (10 - 13 min.)	Easy Iron (Anticrease Stop)	Drain Only (No Spin)	Fabric Softener Only Cycle	Rinse Cycles (25 min.)
---------------------	--------------------------------------	---------------------------------------	--------------------------------	-----------------------------------	----------------------------------

Start and Programs

Washing Options

Option	What it does...	How to set it...	Note
KNOBS TEMPERATURE	Changes the preset wash water temperature of the selected program	Rotate TEMPERATURE knob to the desired wash temperature	<ul style="list-style-type: none"> Rinse water is always COLD
SPIN SPEED	Changes/excludes the preset spin cycle of the selected program	Rotate SPIN SPEED knob to the desired speed	<ul style="list-style-type: none"> Select  for No Spin Faster spinning will extract more water from highly absorbent fabrics
BUTTONS Soaking	Adds a one hour soak to the selected washing program	Press SOAKING button (in)	<ul style="list-style-type: none"> During soaking, laundry is gently tumbled
Extra Rinse	Adds one extra rinse to the selected Cotton Heavy Duty or Permanent Press program	Press EXTRA RINSE button (in)	<ul style="list-style-type: none"> Recommended for very large loads, when too much detergent is used or for detergent contact allergies.
Easy Iron	Automatically stops the selected Permanent Press or Hand Washables program before the spin cycle begins. Laundry soaks in water until the Easy Iron button is pressed again.	Press EASY IRON button (in) Program will stop when it reaches the ◀ symbol on the Programs dial. To resume the program, Press EASY IRON button again (out)	<ul style="list-style-type: none"> Prevents wrinkles caused when laundry is not removed promptly from the drum. Use this option when you know you won't be able to remove the laundry until long after the cycle is finished.
Pre-Wash	Adds an extra wash to the selected program (Not available in "Wool" cycle)	Press PRE-WASH button (in)	<ul style="list-style-type: none"> Recommended for heavily soiled loads like work clothes or children's clothes.
<i>On PROGRAMS Dial</i> DELAY TIMER	Delay's the start of the washing program by 1, 3, 9 or 12 hours so laundry is ready when you are.	<ol style="list-style-type: none"> Rotate PROGRAMS dial clockwise and select 1h, 3h, 9h, or 12h. Press ON-OFF button (in). Wait 5 seconds for the ON-OFF light to stop flashing. Rotate the PROGRAMS dial clockwise and select a washing program. 	<ul style="list-style-type: none"> The On-Off lamp will flash (<i>1 second on, 4 seconds off</i>) to indicate a Delay Start has been set. The door can be opened or closed at any time before the cycle begins.
● Stop/Reset	Cancels/Interrupts the selected program	<ol style="list-style-type: none"> Rotate the PROGRAMS dial clockwise to a Stop/Reset position. Wait 5 seconds. Rotate the PROGRAMS knob to the desired washing program or Drain (see right). 	<ul style="list-style-type: none"> To cancel a program completely, select  (Drain). After the washer drains, wait for the DOOR LOCK light to extinguish before attempting to open the door.

Dispenser Drawer



Automatic Dispenser Drawer

Once loaded in the proper compartment(s) in the dispenser drawer, Detergent, Fabric Softener and Bleach will automatically be added at the appropriate time during the washing program.

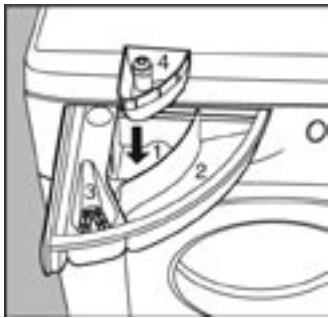

Dispenser Compartments (above)

1. Detergent for Pre-Washing (powder only)
2. Detergent for Washing (powder or liquid)
3. Liquid Fabric Softener
4. Liquid Bleach

HE Laundry Powder

For best results, use HE (High Efficiency) detergent. HE laundry detergents dissolve more quickly in less water and won't overfoam in front loading washers.



Splendide All-Natural Premium Laundry Powder (Part No. 1005)

About Using Bleach (Compartment 4)

- Bleach can only be used when HOT is selected on the **TEMPERATURE** knob
- If bleaching is necessary, the Bleach Compartment 4 (provided) must be inserted into compartment 1.
- Always dilute bleach before using.
- If used, you will see water in the Bleach compartment after the washing program is complete. This is normal.
- Bleach cannot be used during the "Silk" washing program.
- Using the Bleach compartment excludes the possibility of using the PreWash cycle.
- DO NOT exceed the Max level (**shown above**). If you overfill the bleach dispenser, bleach will run directly into the machine and may possibly damage clothes.



Bleach "Max" level

Laundry Aid	Amount	Special Note	Detergent Facts
COMPARTMENTS 1, 2 Powder Detergent	1 to 2 Tablespoon(s)	<ul style="list-style-type: none"> • Powder detergent is recommended. 	<ul style="list-style-type: none"> • Never use too much detergent or additives. Using too much will cause excessive sudsing, and scaling which may reduce performance and cause possible damage to your washer. • NEVER use detergent for "hand washing" or a detergent that is not designated for "machine use." • When washing in COLD water, reduce amount of detergent
COMPARTMENT 2 Liquid Detergent	¼ to ½ Tablespoon	<ul style="list-style-type: none"> • If using liquid detergent, ALWAYS add detergent to compartment no more than a few seconds before the start of the wash cycle. 	
COMPARTMENT 3 Liquid Fabric Softener	½ to 1 Tablespoon	<ul style="list-style-type: none"> • Using a liquid fabric softener (or a detergent with a built-in softener) fluffs clothes. This helps speed drying times and reduce wrinkles. • Fabric perfumes can be used in this compartment. • Using more than the recommended amount of fabric softener can impair wash results. 	

Maintenance and Care

When you should switch off the electricity and turn off the water faucets

Unplug the washer and turn off the water faucets when not using it, when cleaning it and during maintenance activities.

After washing is complete, always

- Turn off the water faucets to relieve pressure on the inlet hoses.
- Wipe the inside of washer door with a soft cloth.

Clean the Exterior

As needed, clean the exterior with a rag dipped in luke-warm water and soap. Never use polish of any kind.

Clean the Interior

In hard water areas or where heavily soiled items are frequently washed, you may periodically need to remove body oils or detergent that has accumulated in the drum. To remove this build-up, run the washer through a complete cycle using HOT water and 2 cups of a non-precipitating water softener.

Periodically, apply a thin coat of paste wax to the inner door (especially the area that is immediately next to the door window) to protect it from laundry aid spills and discoloration.

Clean the Dispenser Drawer

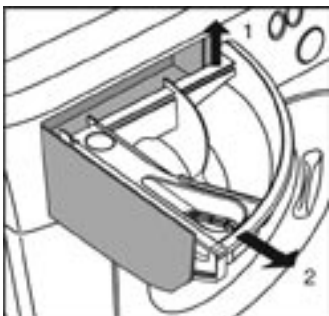

As needed, rinse buildup of detergent or other laundry aids from the dispenser drawer. To remove the dispenser drawer, pull it outwards, as indicated in the picture. Then leave it under warm running water for a few minutes.

Clear the coin trap

This washer contains a self-cleaning pump that does not require any cleaning or maintenance. However, small objects (like coins, hair clips, keys, etc.) may accidentally fall into the pump. To avoid possible damage, they are withheld in an accessible coin trap, located at the bottom, right corner of the washer.

If needed, follow these instructions to remove items that may have accidentally been washed and got caught in the coin trap:

1. With the washer OFF and empty, gently ease down the top of the kick-plate panel (**right**) with a flat blade screwdriver or plastic putty knife.
2. Remove the panel by lifting slightly and pulling forward.
3. Place a small pan or towel under the pump to catch any water still left in the pump.
4. Turn the large knob **counterclockwise** and then pull the filter straight out.
5. When finished cleaning, reinstall the filter and ensure that it's securely tightened. Finally, re-fit the kick-plate panel.



Check the Rubber Inlet Hoses Yearly

Inspect the inlet hoses yearly. If you see any cracks, bulges or other signs of wear replace the hose immediately. Record the hose installation/replacement dates on hoses for future reference.

IMPORTANT!

Always replace the inlet hoses after 5 years of use.

Maintenance and Care



Winterization (for RV or marine installs)

A) To winterize your washer-dryer

- 1) With machine power OFF, pour ½ quart of RV-type antifreeze into washer drum
- 2) Close door. Advance **Program Dial** to a ⌚ 'Spin' position
- 3) Press **ON-OFF** Button (IN). Wait 1-2 minutes
- 4) Press **ON-OFF** Button (OUT). Unplug washer-dryer from electrical outlet (or disconnect power)
- 5) Turn water supply faucets OFF. Disconnect inlet hoses from faucets. Drain remaining water from the hoses. **FINISHED.**

Optional RV Winterization - *If currently pumping antifreeze through a fresh water system*

- 1) With machine power OFF, turn **WASH TEMP** knob to HOT
- 2) Advance **Program Dial** to cycle 3
- 3) Press **ON-OFF** button (IN). Let machine fill until antifreeze is in the drum
- 4) Advance **Program Dial** to • 'RESET'. Wait 5 seconds
- 5) Advance **Program Dial** to a ⌚ 'Spin' position. Let the antifreeze drain from the drum
- 6) Advance **Program Dial** to • 'RESET'. Wait 5 seconds.
- 7) Press the **ON-OFF** button (OUT)
- 8) Turn **WASH TEMP** knob to COLD
- 9) Repeat steps 2 through 7. **FINISHED.**

B) To use again, flush water pipes, then

- 1) Reconnect water inlet hoses to corresponding HOT/COLD faucets. Turn faucets ON. NOTE: Check water inlet hoses and pump periodically (*see Users Guide*).
- 2) Plug washer-dryer in to appropriate electrical outlet (*see Users Guide*) - or reconnect power supply
- 3) With **ON-OFF** button in the OFF (OUT) position, pour ½ TBSP. of powder detergent (or liquid equiv.) into the 'Detergent' compartment inside the Dispenser Drawer (*see Users Guide*).
- 4) Advance **Program Dial** to cycle 4
- 5) Press **ON-OFF** button (IN). Allow machine to run through complete cycle to clean out any remaining antifreeze. **FINISHED.**

Troubleshooting

Before you call our Customer Care Department, go through the following troubleshooting suggestions

Problem:	Possible Causes / Solutions:
The washer won't start.	<ul style="list-style-type: none"> • The plug is not plugged into the socket, or not making contact. • There has been a power outage. • The fuse has blown. • The door is not closed securely. • The ON-OFF button is not pressed (in) • The Programs dial has not been set correctly (<i>see Preset Washing Programs</i>) • The water supply faucets are not turned on
The washer won't fill.	<ul style="list-style-type: none"> • The hose is not correctly connected to the tap. • The inlet hose filter screens need to be cleaned. If work has recently been carried out on the water piping, or if water is very hard, the filters could be clogged with particles or debris. • The rubber hoses are kinked or squashed.
The Programs dial keeps turning.	<ul style="list-style-type: none"> • Wait for the washer to drain, then Stop/Reset the washer (<i>see Washing Options</i>). Set another program. If the knob continues to turn, contact our Customer Care Department.
The washer is continuously filling and draining with water.	<ul style="list-style-type: none"> • The drain hose is positioned too low. It must be installed at a height ranging from 25" to 34". • The end of the drain hose is under water. • The wall drainage system does not have a breather pipe. • There may be a problem with your drain trap if the washer is installed on an upper floor of a building.
The washer does not drain or spin.	<ul style="list-style-type: none"> • The Easy Iron function is selected (<i>see Washing Options</i>) • The Coin Trap is clogged (<i>see Clear the Coin Trap</i>) • The drain hose is kinked or squashed. • The drain hose is clogged or positioned incorrectly so it is blocking water flow.
The washer vibrates excessively during the spin cycle.	<ul style="list-style-type: none"> • The shipping bolts and spacers have not been removed. • The washer is not leveled correctly.
The washer leaks.	<ul style="list-style-type: none"> • The inlet hoses are not secured properly. They should be tightened by hand but not forced. • The detergent dispenser needs to be cleaned (<i>see Clean the Detergent Dispenser</i>) • The drain hose is not secured properly.
There is too much foam.	<ul style="list-style-type: none"> • Improper detergent for this washer (<i>see Dispenser Drawer</i>) • Too much detergent has been used (<i>see Dispenser Drawer</i>) • To clear excess suds, set the Programs dial to "Rinse" and allow the machine to rinse out.

If you still have a problem, call Westland Sales: 1-800-356-0766

Please have the following info ready when you call:

1) Nature of the malfunction 2) Model no. (AW122NA) 3) Serial number (i.e. S/N...)



Spare Parts



This washer is a complex machine. Repairing it yourself or having a non-authorized person try to repair it could cause harm to one or more persons and to the machine, and could invalidate the warranty.

**Always call Westland Sales first if you experience any problems with this machine.
Contact number: 1-800-356-0766 or 503-656-2280.**

Technical Details

Technical Details			
Model	AW122		
Dimensions	23 1/2"	(59.5 cm)	wide
	32 3/4"*	(85 cm)	high
	22 1/2"	(53 cm)	deep
* With legs screwed all the way in			
Capacity	2 to 12 lbs (7 kg)		
Electric Connections	120 V 60 Hz (min. working 108V) max. absorbed power: 1350 W, 12 A.		
Water Connections	max. pressure:	100 psi (689.6 kPa)	
	min. pressure:	20 psi (137.9 kPa)	
Spin Speed	up to 1200 rpm		
	This appliance was tested by UL and conforms with both Canadian and U.S. UL safety requirements and displays their Mark		
	Indesit Company offers their customers products with the Energy Star label		

As a result of technological progress, the manufacturer reserves the right to make any improvements to its appliances without giving prior notice to its clientele.

Recessed, closet and alcove installation (Instructions)

The machine may be installed in a recessed area, closet or alcove.

The installation spacing is in inches and is the minimum acceptable. Additional spacing should be considered for easy installation, servicing and compliance with local codes or ordinances. Other installations must use the minimum dimensions indicated.

Additional clearances for wall, door and floor moldings may be required.

Minimum Clearances

Sides	0"
Front/Back	1"

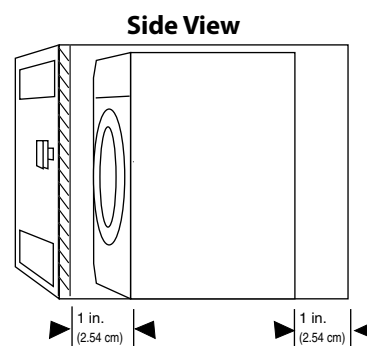
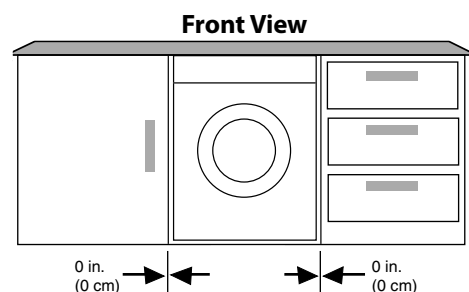

Installation Requirements



Tools and Parts

Assemble the necessary tools and supplies before beginning the washer installation. The parts supplied are in the drum.

Tools needed for installation:
10mm Wrench, Screwdriver

Parts Supplied



U-Clamp



Transit Bolt Hole Plugs (4)

If You Have	You'll Need to Buy
No access to Hot/Cold water hookups	Splendide Faucet Adapter kit, Part No.154187104A (8ft , 2.4m)
Water damage Concerns	Splendide Drain-A-Way™ Pan , Part No. PI-22, PI-24 (or similar)
Floor drain	Siphon break kit (<i>sold at most hardware stores</i>)
Disposer drain	"Y" connector (<i>sold at most hardware stores</i>)
Shifting Concerns (RV and Marine Installations)	<p>Splendide SecureFit™ installation Brackets, Part No. MK01. Keeps washer in place during travel to prevent:</p> <ul style="list-style-type: none"> • Kinked inlet hoses • Disconnected dryer vent hoses • Crushed dryer vent hose • Blocked dispenser drawer • Knobs rubbing against closed doors • Scuffed cabinet woodwork

All Splendide parts are available
direct from Westland Sales: 1-800-356-0766

Location

Selecting the proper location for the washer-dryer improves performance and minimizes noise. Proper installation is your responsibility. The washer-dryer can be installed under a counter, in a closet, in an alcove, or in a recessed area with minimum installation clearances of 0" sides, 1" front/back.

You'll Need

- A water heater set to deliver 120°F (49°C) water to the washer.
- A grounded electrical outlet located within 6 ft. (1.8m) of where the power cord is attached to the back of the washer. (**See "Electrical Requirements."**) Make sure the electrical socket is accessible so you can unplug the washer when not in use.
- Hot and cold water faucets located within 8ft. (2.4 m) of the hot and cold water fill valves, and water pressure of 7.5-100 psi.
- A solid, level floor that can support at least 280 lbs. (127 kg). DO NOT install on carpet. The machine must rest solid on a sturdy floor for optimum performance and minimum vibration.
- Enough space to open the door fully so you can load and unload easily.
- **RV/Marine Installations:** When locating the appliance in a towable trailer or watercraft, position the machine over the axles or mid-ship where movement is at a minimum. Block the machine to prevent extreme movement or tipping.

Water Inlet Requirements

Water pressure must range within 7.5 and 100 psi. If the water pipes are new or left unused, before connecting the machine, run the water until clear to remove debris. Connect the inlet hose to a cold water tap having a 3/4" BSP thread. Ensure that there are rubber washers at the end of each inlet hose. The L-Shaped end goes on the machine and the straight ends on the water faucets.

CAUTION!

1. **This washing machine must only be operated with cold and hot tap water. Do not connect the appliance to a mixer tap of an unpressured hot-water boiler.**
2. **To prevent water damage, the hot and cold water valves should be accessible when the washer is in place and should always be turned off when the washer is not in use.**

Installation Requirements

Drain System Requirements

The washer-dryer can be installed using the standpipe drain system, floor drain system or the sink drain system. To prevent siphoning, the outlet end of the drain hose (provided with unit) **MUST** be at least 20" (50.8 cm) above the base of the machine. Not more than 6" (15.24 cm) of the drain hose should be inserted into the drain pipe.

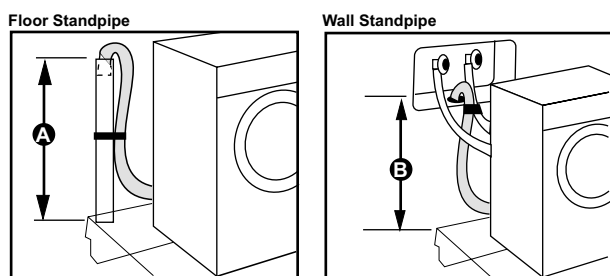

A & B = 25" (62 cm) min. / 34" (86 cm) max.

The standpipe drain requires a minimum diameter standpipe of 1-1/4" (3.2 cm). The minimum carry-away capacity can be no less than 7 gal (26.5 L) per minute. The top of the standpipe must be at least 25 in. (62 cm) high and no higher than 34" (86 cm) from the bottom of the washer.

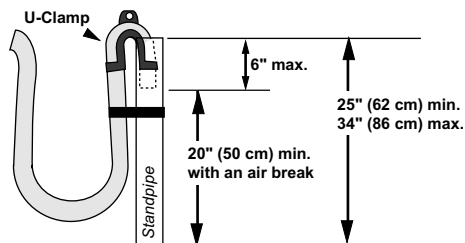

The floor drain system requires a siphon break that may be purchased separately.

The sink drain system connected to a garbage disposer requires a "Y" connector (sold separately).

Sink Drain W/ "Y" Branch Tailpiece

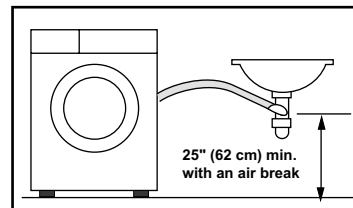

Laundry Sink Drain

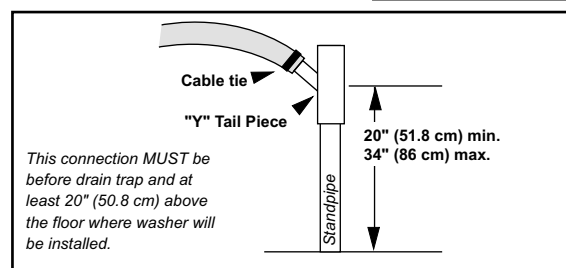
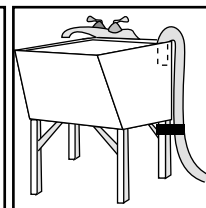

Floor Standpipe w/ "Y" Branch Tail Piece

Optional Splendide Faucet Adapter Kit, Part No. 154187104A

- Supplies water from the faucet and discharges water directly into the sink.
- Designed for installations where washer-dryer hookups are not available.



Faucet Adapter Kit, Part No. 154187104A

Splendide Drain-A-Way™ Pan, Part No. PI-24, PI-22

- Durable, rotomolded pan with seamless construction and reinforced corners.
- Fits under the washer.
- Designed to protect against water damage in the event of overflow or flooding.



Drain-A-Way Pan, Part No. PI-22

Installation Requirements



Electrical Requirements

GROUNDING INSTRUCTIONS Electrical Shock Hazard (Death, Fire, or Electric Shock)

This appliance must be grounded.

This appliance should be connected to an Individual Branch Circuit with N.14 AWG Wire and Protected by 15A fuse

In the event of a malfunction, or breakdown, grounding will reduce the risk of electric shock by providing a path of least resistance for electric current. This appliance is equipped with a cord having an equipment grounding conductor and grounding plug. The plug must be plugged into an appropriate outlet that is properly installed and grounded in accordance with all local codes and ordinances. DO NOT modify the plug provided with the appliance. If it will not fit the outlet, have the proper outlet installed by a qualified electrician.

WARNING: Improper connection of the equipment-grounding conductor can result in a risk of electric shock. Check with a qualified electrician or serviceman if you are in doubt as to whether the appliance is properly grounded.

WARNING



ELECTRICAL SHOCK HAZARD

Plug washer-dryer into a grounded 3 prong outlet.

Do not remove ground prong.

Do not use adapter.

Do not use an extension cord.

Failure to follow these instructions can result in death, fire, or electrical shock.

- A 120-volt, 60-Hz., AC-only, 15 or 20-amp, fused electrical supply is required. Time-delay fuse or circuit breaker is recommended. It is recommended that a separate circuit serving only this appliance be provided.
- This washer-dryer is equipped with a 6' power supply cord having a 3-prong ground plug.
- To minimize possible shock hazard, the cord must be plugged into a properly grounded (3) prong electrical outlet capable of 120 Volt, 60 Hz and grounded in accordance with local codes and ordinances. If a mating outlet is not available, it is the personal responsibility and obligation of the customer to have the properly grounded outlet installed by a qualified electrician. The outlet shouldn't be controlled by a wall switch or pull cord which can be turned off accidentally.
- If codes permit and a separate ground wire is used, it is recommended that a qualified electrician determine that the ground path is adequate.
- Do not ground to a plastic plumbing lines, gas lines or water pipes.
- Check with a qualified electrician if you are not sure the washer is properly grounded.
- DO NOT use an extension cord.
- DO NOT have a fuse in the neutral or ground circuit.
- DO NOT install or store this appliance where it will be exposed to weather or in an area where gasoline or other flammables are stored.

Installation Instructions

WARNING



EXCESSIVE WEIGHT HAZARD

Use two or more people to move and install the washer-dryer.

Failure to do so can result in back or other injury

Remove the Transit Screws/Spacers

First, position the washer so that the rear of the unit is within approximately 3 feet (90 cm) of the final location. There are 4 bolts in the rear panel of the washer that support the suspension system during transportation.

1. Using a wrench, loosen each of the bolts.
2. Once loosened, pull out the bolt, including the rubber grommet and the plastic spacer covering the bolt.
3. Once all 4 bolts are removed, close the holes with the transit bolt hole plugs (provided).
4. Keep the bolts, rubber grommets and plastic spacers in a safe place. These items should be reinstalled if the machine is transported in the future.

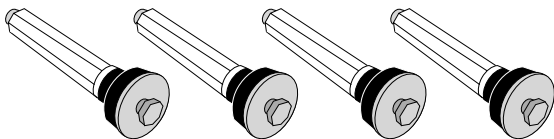
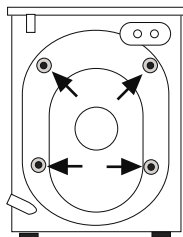

IMPORTANT!
Transit Screws/Spacers must be removed before use.

Route the Drain Hose

Proper routing of the drain hose protects your floors from damage due to water leakage. Carefully read and follow these instructions.

The drain hose is connected to the washer. To prevent drain water from going back into the washer:

- Do not straighten the drain hose, and do not force excess drain hose into the standpipe. Hose should be secure, but loose enough to provide a gap for air.
- When routing the drain hose through cabinets or walls, use a protective material such as electrical tape to cover sharp edges that could damage the hose.

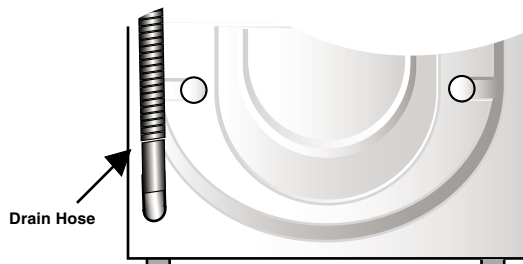

Connect the Inlet Hoses

Before connecting any hoses, run the faucets until the water is clear to remove any debris. Make sure the drum is empty. Please use the new hoses supplied. Old hoses may cause leaks due to worn out washers or may be split due to water pressure.

1. Connect the angled ends of the hoses to the inlet valves at the back of the machine (20mm threads). Screw on the couplings **BY HAND** until they are seated on each gasket.

Installation Instructions



2. Attach the hose connected to the 'H' valve to the hot water faucet. Screw on the coupling BY HAND until it is seated on the gasket. **DO NOT OVERTIGHTEN.**
3. Attach the hose connected to the 'C' valve to the cold water faucet. Screw on the coupling BY HAND until it is seated on the gasket. **DO NOT OVERTIGHTEN.**
4. Turn on the water faucets and check for leaks.

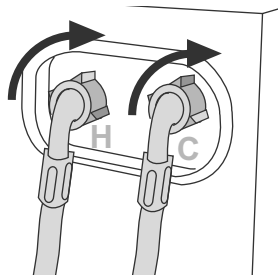

IMPORTANT!

The couplings should be tightened BY HAND, a tool should only be used if a leak occurs. Do not use excessive force.

Secure the Drain Hose

1. Drape the power cord over the washer top.
2. Secure the drain hose to the laundry tub leg or standpipe with a strap or cable-tie.
3. Use the U-Clamp (provided) and insert the drain hose into the standpipe or sink. **DO NOT** force excess drain hose into the standpipe. There should be only 6" of drain hose in the stand pipe.

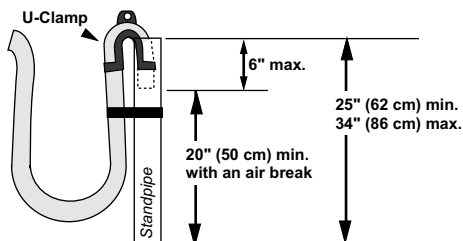

Level the Washer-Dryer

After positioning the washer in its final installation location, you must level the washer.

The front feet are self locking and adjustable. Your machine will be noisy if the two front feet are not adjusted so the machine stands firm and level.

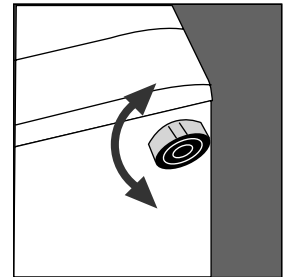

1. Tilt the machine back, leaning it against the wall.
2. Adjust the front feet up or down to ensure the washer is resting solid and does not rock side-to-side or front-to-back when the machine is upright.

IMPORTANT!

When moving washer to its final location, take care not to kink the inlet or drain hoses.

Optional Splendide SecureFit™ Installation Brackets, Part No. MK01

- Hook around two front feet and screw into the floor.
- Designed to keep the washer from shifting front-to-back or left-to-right.
- Recommended for RV or Marine Installations.



SecureFit Brackets, Part No. MK01

DID YOU KNOW?

The majority of problems with noisy machines or excessive vibration are due to the transit **SCREWS/SPACERS NOT BEING REMOVED** or the **FEET NOT BEING ADJUSTED** correctly to level the machine.

Installation Instructions

Complete the Installation

- Check to be sure all parts are now installed. If there's an extra part, go back through the steps to see which step was skipped.
- Check to be sure you have all your tools.
- Dispose/recycle all packaging materials.
- Read this manual.

Final Installation Checklist

- Instructions and Installation Kit have been removed from the tub.
- Transit bolts/spacers have been removed.
- Washer is plugged into electrical outlet and is properly grounded.
- Water hoses are connected to the faucets with inlet screens and washers.
- Water is turned on and checked for leaks at faucet and water valve connections.
- Drain hose is properly located into drain facility and is not collapsed or damaged.
- Washer has been leveled.
- Test for proper operation (*see below*)

To test and clean the washer

Measure 1 to 2 tbsp. of powdered High Efficiency (HE) detergent.



Splendide All-Natural Premium HE Laundry Powder, Part No. 1005 - Available from Splendide (Westland Sales)

- Pour the detergent into compartment 2 in the dispenser drawer (*see Dispenser Drawer*).
- Select program "4" on the **PROGRAMS** dial.
- Select **HOT** on the **TEMPERATURE** knob
- Press the **ON-OFF** button (in). Allow the washer to complete the full cycle. (It will take approx. 40 min.)



WARNING



ELECTRICAL SHOCK HAZARD

Plug washer-dryer into a grounded 3 prong outlet.

Do not remove ground prong.

Do not use adapter.

Do not use an extension cord.

Failure to follow these instructions can result in death, fire, or electrical shock.

IMPORTANT!

Should you move residence in the future, the Transit Screws/Spacers should be reinstalled to support the inside of the washer and prevent damage **WHEN TRANSPORTING**.



© Copyright 2006, Westland Sales, Clackamas, OR 97015

1-800-356-0766

www.westlandsales.com