

#SK02 STACK KIT MOUNTING INSTRUCTIONS AND PATTERN

FOR USE WITH A566VX 110V ELECTRIC DRYER & AW122 FRONT-LOADING WASHER

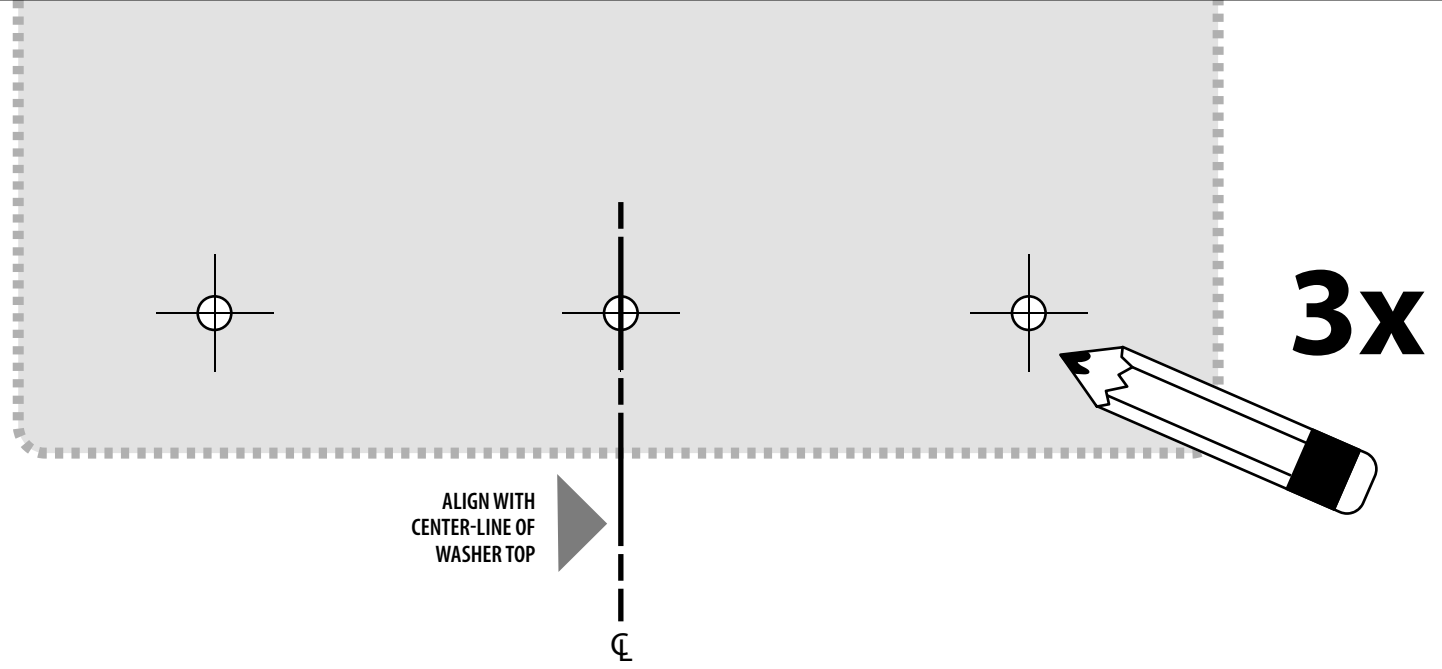

THIS KIT IS INTENDED TO PROVIDE FOR EASIER INSTALLATION AND REMOVAL OF THE WASHER AND DRYER IN CLOSE-FITTING RV AND MARINE INSTALLATIONS. THIS KIT MAY ALSO BE USED TO SECURE THE DRYER ON TOP OF A STURDY, WOODEN SHELF.

1x

C

1x

E

F

1x

E

G

7x

D

D

SIZE
3/32"

3x

F

DRILL BIT NOT INCLUDED

Self-Tapping

DRILL BIT NOT INCLUDED

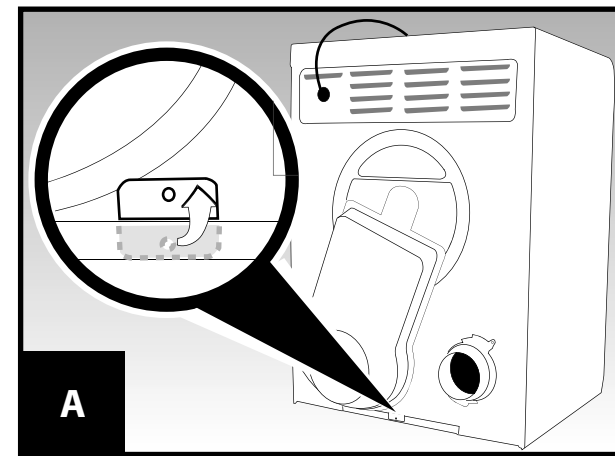

A Bend tab up so rear bracket can be inserted later

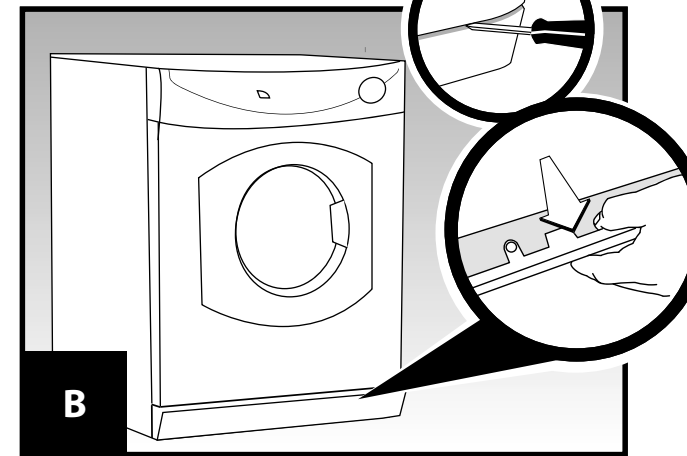

B Remove dryer kick-plate

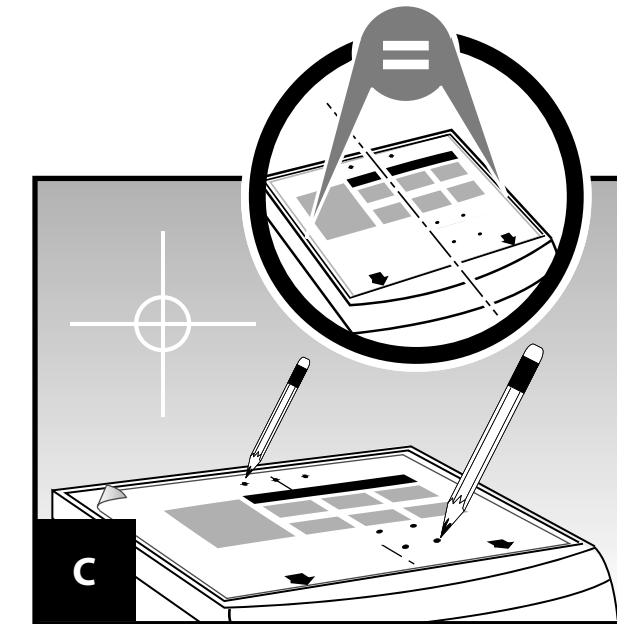

C Use pattern to mark drill hole positions on washer top

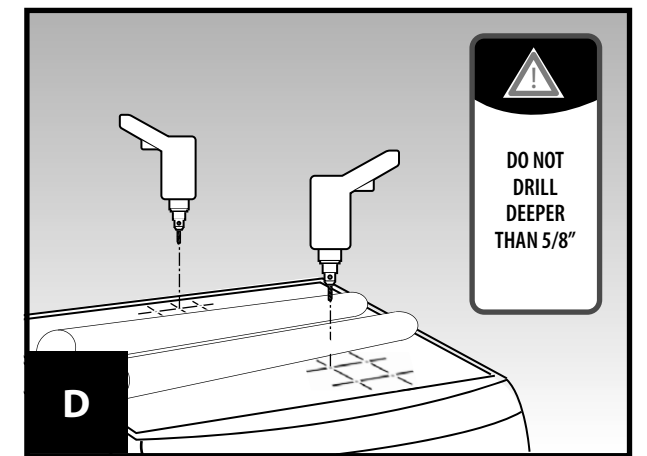

D Drill holes into washer top

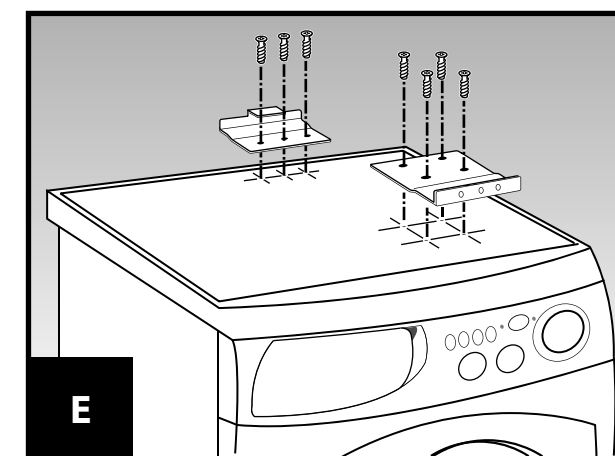

E Secure brackets to washer top

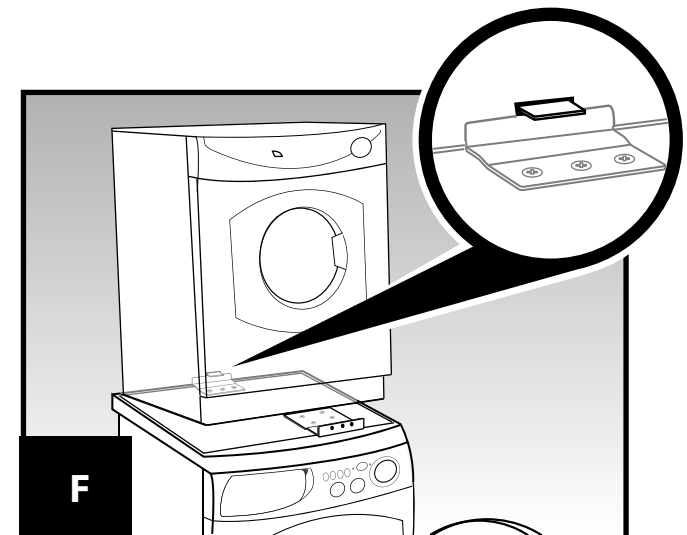

F Insert rear bracket into dryer

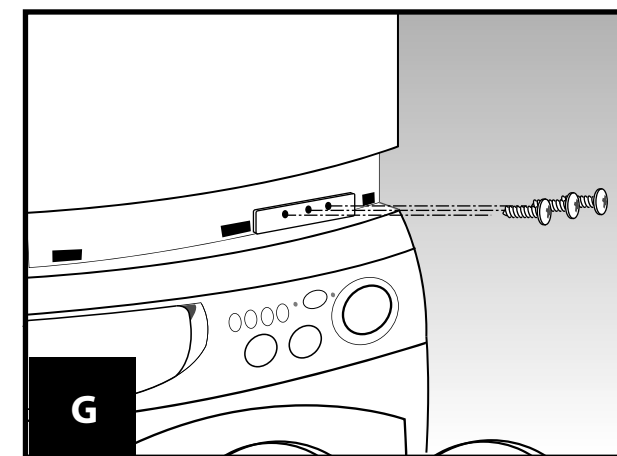

G Secure front bracket to dryer

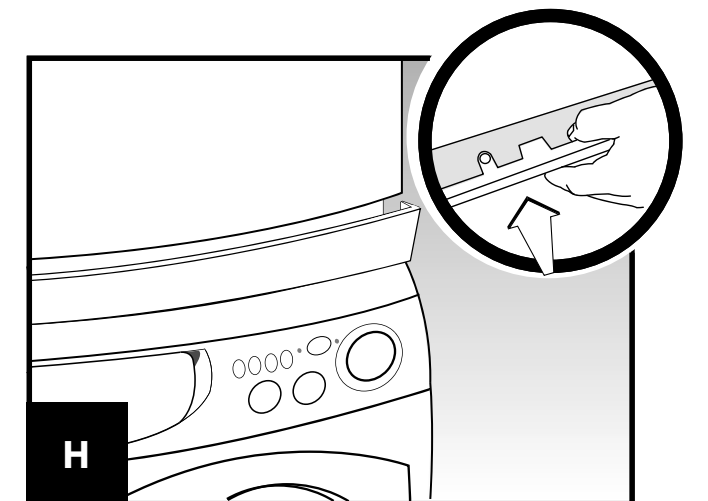

H Reinstall dryer kick-plate

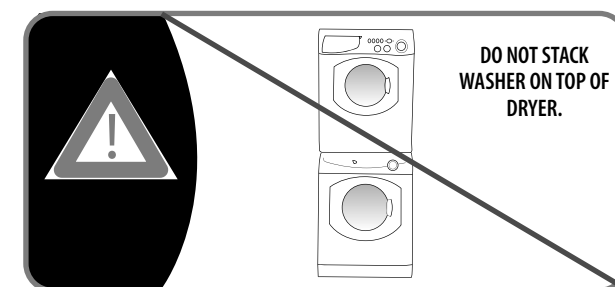
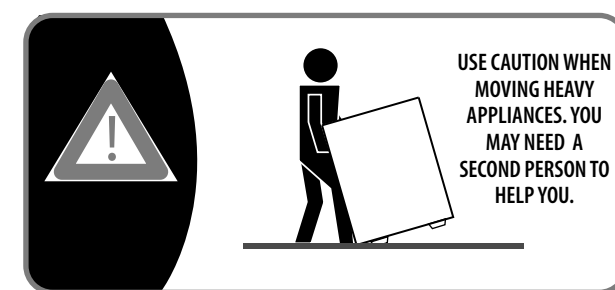

4x

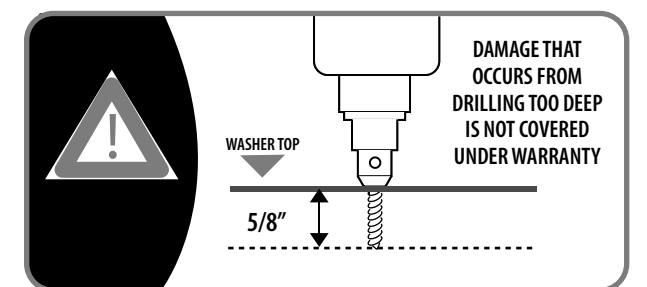
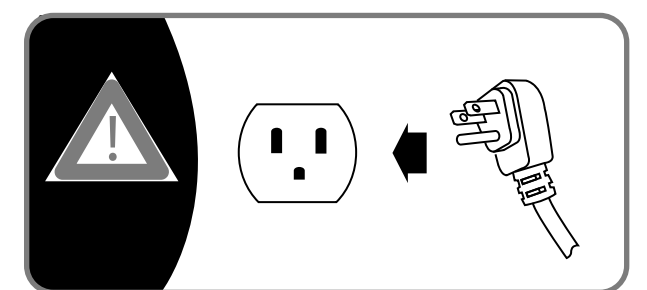
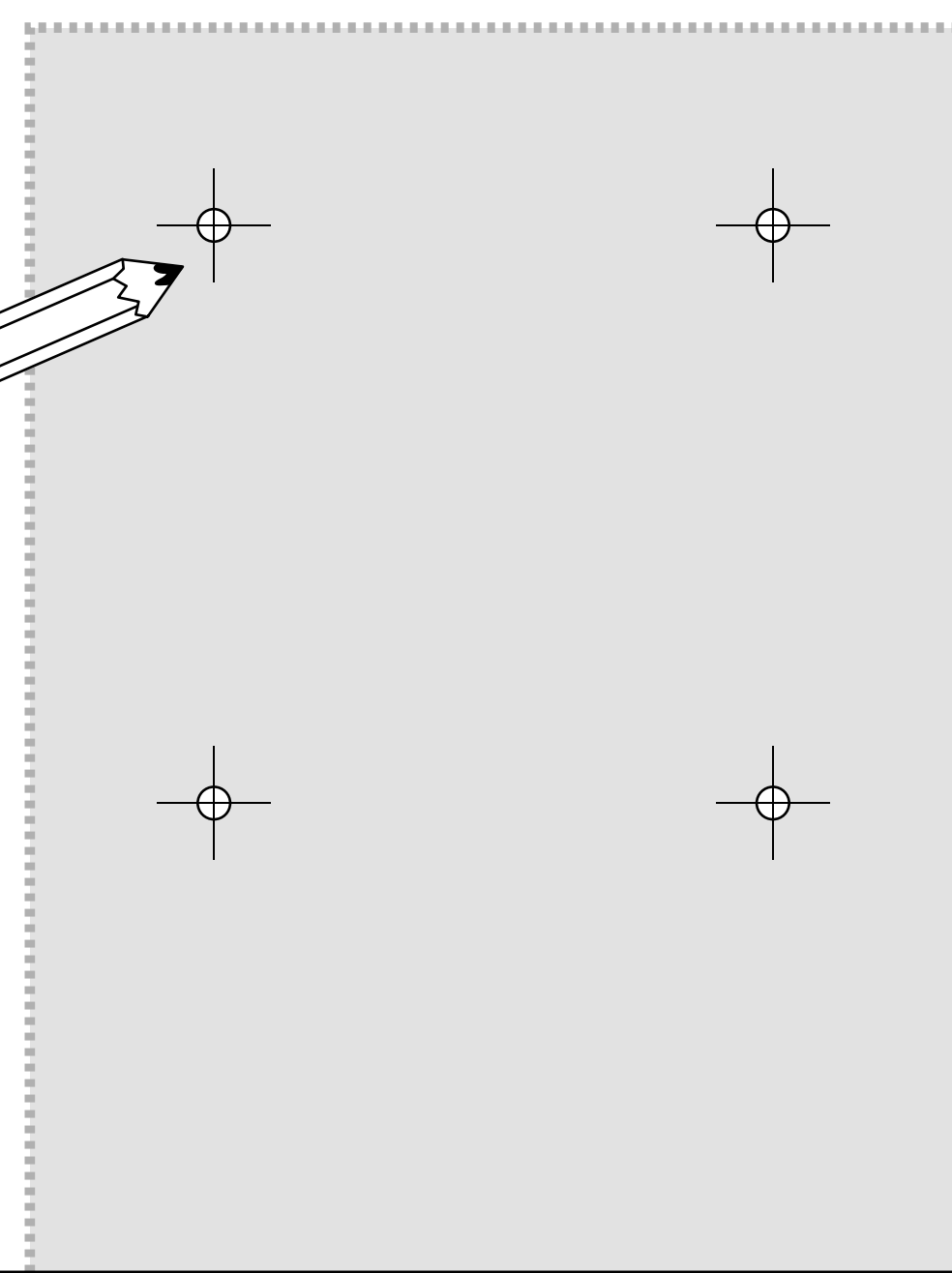

USE ONLY SCREWS FROM KIT

