



Splendide
TECHNICAL EDUCATION
GROUP PRESENTS



WD802M (Splendide 2000)
WDC1025M (Comb-o-matic 6000)
WDC1025MCEE (Comb-o-matic 6100)
WDC1024M (Comb-o-matic 2000)

Front-Loading Automatic Washer-Dryer

Manufacture Years: 1996 - 2002

Training Guide

Part No. TRAINMANM

Contact Info

Product Specifications & Warranty Info

Westland Sales, Splendide Tech Dept.
1-800-356-0766 EXT. 5
(503-655-2563)

Technical Assistance & Parts Ordering

Westland Sales, Splendide Tech Dept.
1-800-356-0766 EXT. 5
(503-655-2563)

Literature Orders

Westland Sales, Splendide Tech Dept.
1-800-356-0766 EXT. 5
(503-655-2563)

Corporate Headquarters

15650 SE 102nd Ave.
(PO BOX 427)
Clackamas, OR 97015

Telephone: 800-356-0766 (503-655-2563)

Service Fax: (503) 722-9202

Service E-mail: service@splendide.com

www.splendide.com/support.htm

Introduction

Westland Sales assumes no responsibility for repairs on Splendide products by anyone other than Authorized Splendide Service Technicians. Warranty repairs must be pre-approved by Splendide. Contact Westland Sales, before servicing any Splendide appliance.

This Training Guide for the “Splendide Front-Loading Automatic Washer-Dryer,” (Part No. TRAINMANM), provides the service technician with information on the installation and service of Splendide washer-dryer models WD802M, WDC1025M/MCEE and WDC1024M. It is to be used as a supplemental training aid for service technicians. For more information on the washer-dryer, refer to the “Use and Care Guide” provided with the appliance, or the job-specific Tech Tips available from Westland Sales.

Training Guide Goals

The goal of this Training Guide is to provide information that will enable the service technician to properly diagnose malfunctions and repair the Splendide Front-Loading Automatic Washer-Dryer.

The objectives of this Training Guide are for the service technician to:

- Understand and follow proper safety precautions.
- Effectively troubleshoot and diagnose malfunctions.
- Successfully perform necessary repairs.
- Help the technician to quickly return the washer-dryer to its proper operational status.



© Copyright 2004, Westland Sales, Clackamas, OR 97015

Contents

General Information	
<i>Model & Serial No. Designators / Warranty Guide / Specs / Important Safety Info.</i>	1-4
Installation Information	
Installation Requirements	
<i>Location</i>	5
<i>Dimensions / Clearances</i>	6
<i>Drain Syst</i>	7
<i>Electrical Req</i>	
Installation Instructions	
<i>Remove Transit Bolts & Spacers / Route Drain Hose / Connect Inlet Hoses</i>	9
<i>Secure the Drain Hose / Level the Washer-Dryer</i>	10
<i>Install Dryer Ducting / Complete the Installation</i>	11
Theory of Operation	
Introduction to the Models / Water System	
<i>Introduction / Water Inlet Valves / Dispenser Distribution System</i>	13
<i>Pressure Switch / Description of Wash and Rinse Temperatures</i>	14
Wash/Dry System	
<i>Module Board / Wash Timer / Main Motor</i>	15
<i>Pump Motor / Two Dryer Heating Elements / How Does Ventless Drying work?</i>	16
Door Lock/Switch Assembly / Suspension System	17
Customer Interface / Cycle Selection System	
<i>Control Panel Assembly</i>	18
<i>Description of Control Panel Buttons & Knobs</i>	19
<i>Description of Cycle Selector Options / Description of Option Buttons</i>	20
<i>Description of Preset Wash Cycles / How to Set A Wash Cycle ONLY</i>	21
<i>Description of Preset Dry Cycles / How to Set a Wash-Dry Cycle / How to Set a Dry Cycle</i>	22
<i>Preset Wash/Dry Cycles Chart</i>	23
Automatic Routines	
<i>Door Locking & Unlocking Routines</i>	24
<i>Wash Quality Routines / Auto Balance Routine</i>	25
Accessing the Components	
Component Locations	27
Top Panel / Wash Timer / Other Control Panel Components	
<i>Removing the Washer-Dryer Top / Removing the Knobs / Removing the Wash Timer</i>	28
<i>Removing Dry Time & Water Temp. Selectors / Removing the Control Panel</i>	29
Door / Door Switch / Porthole Diaphragm	
<i>Removing the Door / Removing the Door Switch / Removing the Porthole Diaphragm</i>	30
Detergent Dispenser Assembly / Water Valves	
<i>Removing the Dispenser Assembly / Removing the Water Valves</i>	31-32
Pressure Switch	32

Drain Pump / Pump Filter	
<i>Removing the Drain Pump</i>	35
<i>Removing the Pump Filter / To Clean Out the Filter</i>	36
Back Panel / Main Motor / Motor Brushes	37
Module Board / Shock Absorbers	38
Component Testing Procedures	
Introduction & Instructions	39
1. Door Switch Test	40
2. Power “in” from the Surge Protector Test	41
3. Pressure Switch Test	42
4. Fan Motor Test	43
5. Heater Coil Test	44
6. Fuse Link and T-Stats Test	45
7. Module Board Test	46
8. Main Motor Tests	47
9. Drain Pump Test	48
10. Push Buttons, Wash Temp. & Dry Time Selectors	
<i>ON/OFF Button / Option Buttons</i>	49
<i>Wash/Rinse Temperature Selector</i>	50
<i>Dry Time Selector</i>	51
11. Wash Timer Test	
<i>Reading the Step Chart / When and How to Perform Wash Timer Tests</i>	52
<i>Wash Timer Step Chart</i>	53-54
Diagnosis & Troubleshooting	
Problem / Testing Procedure Chart	55-56
Tech Tips	
Performing a Dryer Airflow & Heat Test / Performing a Pump Failure Test	57
Replacing the Wire Connections on the Pressure Switch	58
Modifying Hoses to Improve Condenser Drying	59
Performing Condenser AirDuct Mainenance	60-61
Winterization Instructions (RV and Marine Installations)	62
Veifying Normal Operation	64
Wiring Diagrams	
WD802M / WDC1024M	
<i>S/N 9616XXXX to 9719XXXX</i>	66
<i>S/N 9720XXXX to 2050XXXX</i>	67
WDC1025M	
<i>S/N 9616XXXX to 9719XXXX</i>	66
<i>S/N 9720XXXX to 9943XXXX</i>	67
WDC1025MCEE	
<i>S/N 9943XXXX to 2050XXXX</i>	68

General Information

Model / Serial No. Designators

This guide covers 'M' models (Serial #'s beginning with 9616 to 205). Use these numbers to obtain the Warranty status as well as a history of repairs and service calls for the washer-dryer. To speed the repair process, ALWAYS have the Model and Serial No. ready when you call Westland Sales.

Model Number	WD	C	1025MCEE
PRODUCT GROUP WD = Washer-Dryer			
PRODUCT IDENTIFICATION C = Condenser Drying System (Ventless model)			
DRUM VOLUME CODE 802M/1024M = 1.5 cu. ft. 1025M/1025MCEE = 1.9 cu. ft.			

Serial Number	PFLP	00	27	0697
YEAR OF MANUFACTURE				
WEEK OF MANUFACTURE				
PRODUCT SEQUENCE NUMBER				

NOTE: When searching the Splendide Warranty Database, add a '6' or a '2' to the front of the serial number for the following models
 WDC1024M=2 WDC1025M/MCEE=6

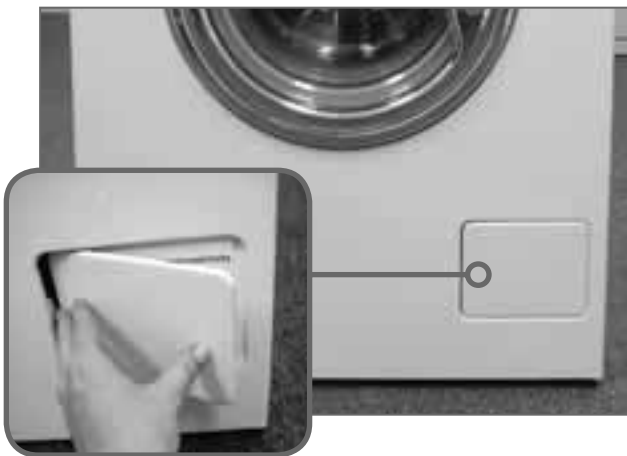

Model Number

Serial Number

Warranty Guide*

Refer to this page for a brief summary of the Product Warranties available by Splendide.

Wty Length	Splendide Will Pay For	Splendide WILL NOT Pay For
<p>MFR 1-YEAR From Date of Purchase</p>	Replacement parts ONLY.	<p>A. Repairs when the washer-dryer is used in other than normal, single-family use.</p> <p>B. Pickup and delivery. The washer-dryer is designed to be repaired on-site.</p> <p>C. Removal/replacement of washer-dryer from built-in or cabinet installations.</p>
<p>LIMITED 2-YEAR From Date of Purchase (Not available for some models)</p>	For two years from the date of purchase WHEN product is registered. Limited replacement parts and repair labor costs. Coverage starts 61 days after the completed warranty registration card is received by Westland Sales.	<p>D. Damage to the washer-dryer caused by accident, alterations, misuse, abuse, fire, flood, acts of God, or use of products not approved by Splendide.</p> <p>E. Repairs to parts or systems resulting from unauthorized modifications made to the washer-dryer.</p>
<p>LIMITED 5-YEAR From Date of Purchase (Not available for some models)</p>	For five years from the date of purchase WHEN extended Protection Plan is purchased. Limited replacement parts and repair labor costs. Coverage starts 61 days after the full payment is received by Westland Sales.	<p>F. Replacement parts or repair labor costs not pre-approved by Splendide and/or provided by an unauthorized service company.</p> <p>G. Service calls to correct the installation of the washer or to instruct you how to use it.</p> <p>H. Plastic parts and cosmetic pieces.*</p>

*IMPORTANT!

This chart should be used ONLY as a guide and DOES NOT supersede the Warranty Statement. For complete information, refer to the Warranty Statement that came with the appliance.

Washer-Dryer Specifications

The following is a list of product specifications for the Splendide Models covered in this Training Guide.

Model Number	WD802M	WDC1025M	WDC1025MCEE**	WDC1024M
COLOR	White	White	White	White
DRYER TYPE	Vented	Ventless	Ventless	Ventless
ELECTRICAL REQ.				
Max. Current	13A	13A	13A	13A
Rated Current	15 A	15A	15A	15 A
Voltage	115V	115V	115V	115V
Frequency	60Hz	60Hz	60Hz	60Hz
Heating Power	1300W	1300W	1300W	1300W / 900W
GALLONS WATER/Wash Cycle*	12-25 Gal.	12-25 Gal.	12-25 Gal.	12-25 Gal.
CAPACITY				
Wash	10 lb.	12 lb.	12 lb.	10 lb.
Dry	6 lb.	6 lb.	6 lb.	4 lb.
MAX SPIN SPEED	1000 RPM	1000 RPM	1000 RPM	1000 RPM
Height	33 1/4"	33 1/4"	33 1/4"	33 1/4"
Width	23 1/2"	23 1/2"	23 1/2"	23 1/2"
Depth	22"	22"	22"	18 1/2"
WEIGHT	185 lb.	185 lb.	185 lb.	175lb.
PROGRAMS				
Wash	5 Cycles	5 Cycles	5 Cycles	5 Cycles
Dry (Button)	2 Temp	2 Temp	2 Temp	2 Temp
WASH TEMPERATURES	5 Options	5 Options	3 Options	5 Options
OPTIONS	3 Buttons	3 Buttons	4 Buttons	3 Buttons

*Water usage varies depending on load size and fabric type. 220V, 50Hz export models available.

**This model contains the following notable differences from the other models described in this guide,

- Control Panel Differences: "Half Water/High Water" button, 3 Wash/Rinse Temperatures
- Internal Differences: a different pressure switch, water temperature selector.

NOTE: WDC1025M/MCEE and WDC1024M models have condenser (ventless) drying systems. Condenser drying systems use 5 gallons of cold water per hour during the dry cycle.

IMPORTANT General Safety Information



Your safety is important. Read this section before you continue.



Important safety messages can be found in this manual and on the appliance. Always read and obey all safety messages.





This is a safety alert symbol. This symbol alerts you to potential hazards that can kill or hurt you and others. All safety messages will follow the safety alert symbol and the word "WARNING."

The safety messages will tell you what the potential hazard is, tell you how to reduce the chance of injury, and tell you what can happen if the instructions are not followed.

 WARNING	
	ELECTRICAL SHOCK HAZARD Disconnect power before servicing. Replace all panels before operating. Failure to do so can result in death or electrical shock.

 WARNING	
	EXCESSIVE WEIGHT HAZARD Use two or more people to move and install the washer-dryer. Failure to do so can result in back or other injury

 WARNING	
	ELECTRICAL SHOCK HAZARD Plug washer-dryer into a grounded 3 prong outlet. Do not remove ground prong. Do not use adapter. Do not use an extension cord. Failure to follow these instructions can result in death, fire, or electrical shock.

Electrostatic Discharge (ESD)

Sensitive Electronics

ESD problems are present everywhere. ESD may damage or weaken the electronic control assembly. The new control assembly may appear to work well after repair is finished, but failure may occur at a later date due to ESD stress.

- Use an antistatic wrist strap. Connect the wrist strap to a green ground connection point or unpainted metal in the appliance; or touch your finger repeatedly to a green ground connection point or unpainted metal in the appliance.
- Avoid touching electronic parts or terminal contacts.

Installation Information

Installation Requirements

Check these location, plumbing and electrical installation requirements for a proper washer-dryer installation.

Tools and Parts

Assemble the necessary tools and supplies before beginning the washer installation. The parts supplied are in the drum.

Tools needed for installation:

Wrench, Screwdriver, 7mm Socket/Ratchet, 13mm Socket/Ratchet

Parts Supplied



U-Clamp



Optional Dryer Lint Filter

If You Have	You'll Need to Buy
No access to Hot/Cold water hookups	Splendide Faucet Adapter Kit, Part No. 154187104A (8ft , 2.4m)
Vented Drying Model	Splendide Vent Kit, Part No. VI-422, VID-401, or similar
Water Damage Concerns	Splendide Drain-A-Way Pan, Part No. PI-22, or similar
Floor Drain	Siphon break kit (Sold at hardware stores)
Disposer Drain	"Y" connector (Sold at hardware stores)

Location

Selecting the proper location for the washer-dryer improves performance and minimizes noise. Proper installation is your responsibility.

The washer-dryer can be installed under a counter, in a closet, in an alcove, or in a recessed area with minimum installation clearances of 0" sides, 1" front/back.

You'll Need

- A water heater set to deliver 120°F (49°C) water to the washer
- A grounded electrical outlet located within 6 ft. (1.8 m) of where the power cord is attached to the back of the washer. (See "Electrical Requirements.")
- Hot and cold water faucets located within 8ft. (2.4 m) of the hot and cold water fill valves, and water pressure of 7.5-100 psi.
- A solid, level floor that can support at least 280 lbs. (127 kg). DO NOT install on carpet.
- **RV/Marine Installations:** Position the machine over the axles or mid-ship and block-in to prevent extreme movement.
- **Vented models:** Rigid or flex/metal dryer ducting. The washer-dryer MUST be exhausted to the OUTSIDE. Exhaust ducts should be as short and straight as possible and must slope downwards and away from the machine. The exhaust duct must end with an approved exhaust vent hood with swing out damper(s) or tailpiece with louvers.

(Continued on the next page)

Washer-Dryer Dimensions

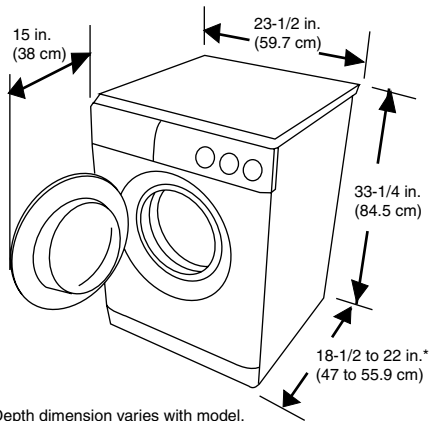

Undercounter Install Requirements

The dimensions shown are for the minimum spacing allowed.

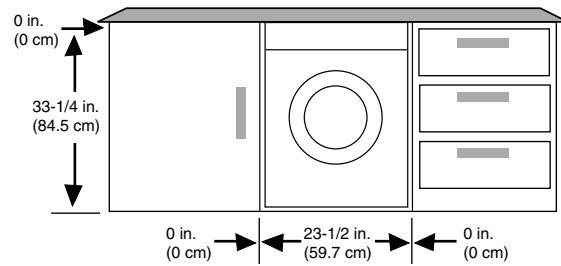

Recessed Area/Closet Install Requirements

The dimensions shown are for the minimum spacing allowed.

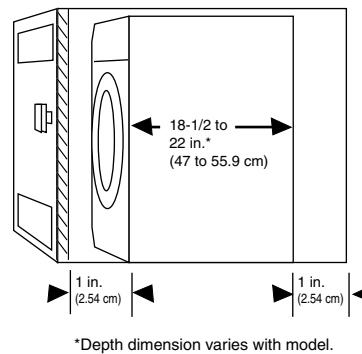

Additional spacing should be considered for:

- Ease of installation and servicing.
- Additional clearances might be required for wall, door and floor moldings.
- If cabinet door is installed, a minimum of 8 sq. in. should be provided for make up air. Louvered doors with equivalent air openings are acceptable.

Drain System Requirements

The washer-dryer can be installed using the standpipe drain system, floor drain system or the sink drain system. To prevent siphoning, the outlet end of the drain hose **MUST** always be 20" (50.8 cm) above the base of the machine. Not more than 6" (15.24 cm) of the drain hose should be inserted into the drain pipe.

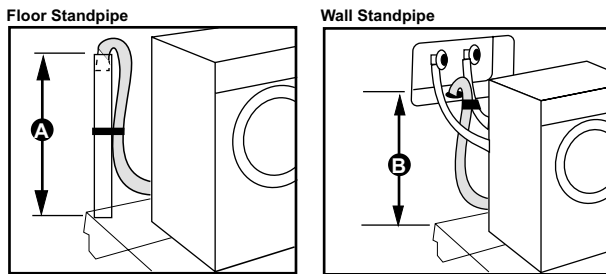

A & B = 25" (62 cm) min. / 34" (86 cm) max.

The standpipe drain requires a minimum diameter standpipe of 1-1/4" (3.2 cm). The minimum carry-away capacity can be no less than 7 gal (26.5 L) per minute.

The top of the standpipe must be at least 25 in. (62 cm) high and no higher than 34" (86 cm) from the bottom of the washer.

The floor drain system requires a siphon break that may be purchased separately.

The sink drain system connected to a garbage disposer requires a "Y" connector (sold separately).

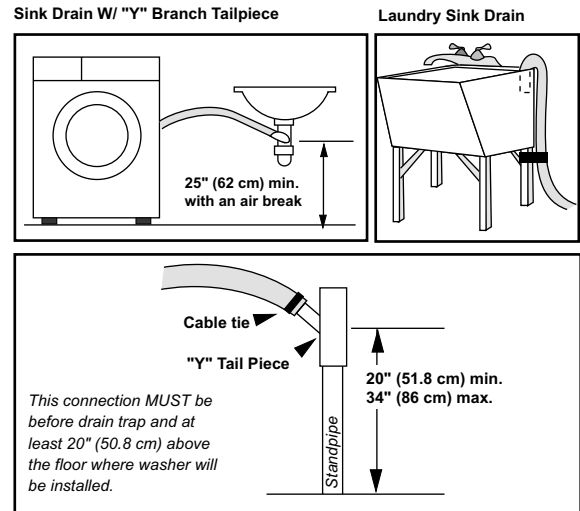
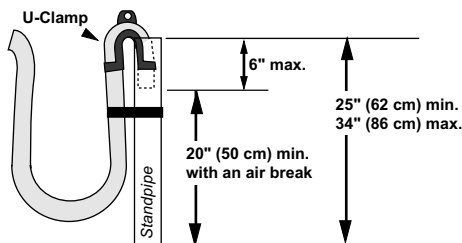

Floor Standpipe w/ "Y" Branch Tail Piece

Optional

- The Splendide Faucet Adapter Kit, Part No. 154187104A
- Supplies water from the faucet and discharges water directly into the sink.
- Designed for installations where washer-dryer hookups are not available.



Faucet Adapter Kit, Part No. 154187104A

(Continued on the next page)

Electrical Requirements

GROUNDING INSTRUCTIONS

This appliance must be grounded. In the event of a malfunction, or breakdown, grounding will reduce the risk of electric shock by providing a path of least resistance for electric current. This appliance is equipped with a cord having an equipment grounding conductor and grounding plug. The plug must be plugged into an appropriate outlet that is properly installed and grounded in accordance with all local codes and ordinances. **DO NOT** modify the plug provided with the appliance. If it will not fit the outlet, have the proper outlet installed by a qualified electrician.

WARNING: Improper connection of the equipment-grounding conductor can result in a risk of electric shock. Check with a qualified electrician or serviceman if you are in doubt as to whether the appliance is properly grounded.

WARNING



ELECTRICAL SHOCK HAZARD

Plug washer-dryer into a grounded 3 prong outlet.

Do not remove ground prong.

Do not use adapter.

Do not use an extension cord.

Failure to follow these instructions can result in death, fire, or electrical shock.

- A 120-volt, 60-Hz., AC-only, 15 or 20-amp, fused electrical supply is required. Time-delay fuse or circuit breaker is recommended. It is recommended that a separate circuit serving only this appliance be provided.
- This washer-dryer is equipped with a power supply cord having a 3-prong ground plug.
- To minimize possible shock hazard, the cord must be plugged into a mating, 3-prong, ground-type outlet, grounded in accordance with local codes and ordinances. If a mating outlet is not available, it is the personal responsibility and obligation of the customer to have the properly grounded outlet installed by a qualified electrician.
- If codes permit and a separate ground wire is used, it is recommended that a qualified electrician determine that the ground path is adequate.
- Do not ground to a gas pipe.
- Check with a qualified electrician if you are not sure the washer is properly grounded.
- **DO NOT** use an extension cord.
- Do not have a fuse in the neutral or ground circuit.
- **DO NOT** install or store this appliance where it will be exposed to weather or in an area where gasoline or other flammables are stored.

Installation Instructions

Follow these instructions in order to prevent installation errors and to assure proper washer-dryer operation.

! WARNING	
	<p>EXCESSIVE WEIGHT HAZARD</p> <p>Use two or more people to move and install the washer-dryer.</p> <p>Failure to do so can result in back or other injury</p>

Route the Drain Hose

Proper routing of the drain hose protects your floors from damage due to water leakage. Carefully read and follow these instructions.

The drain hose is connected to the washer:

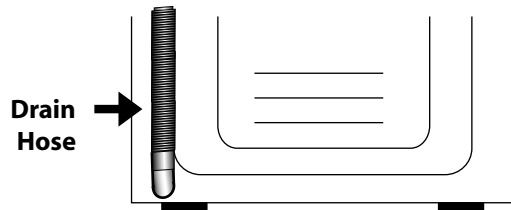

Remove the Transit Bolts/Spacers

First, position the washer so that the rear of the unit is within approximately 3 feet (90 cm) of the final location. There are 8 bolts and 4 brackets inside the rear panel of the washer that support the suspension system during transportation.

1. Using a 7mm socket (or Flat-Head Screwdriver), remove the 3 screws that secure the rear panel to the case.

2. Once the rear panel is removed, use a 13mm socket to remove the 8 bolts that secure the 4 metal transit brackets to the case and drum (see right).

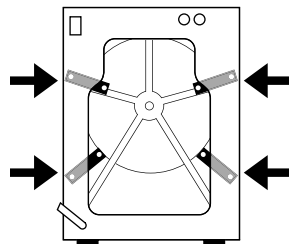

3. Once all 8 bolts and 4 brackets are removed, reinstall the rear panel. Then, close the 4 holes in the case with the transit bolt hole plugs (provided).

4. Keep the 8 bolts and 4 metal spacers in a safe place. These items should be reinstalled if the machine is transported in the future.

To prevent drain water from going back into the washer:

- Do not straighten the drain hose, and do not force excess drain hose into the standpipe. Hose should be secure, but loose enough to provide a gap for air.
- When routing the drain hose through cabinets or walls, use a protective material such as electrical tape to cover sharp edges that could damage the hose.

Connect the Inlet Hoses

Before connecting any hoses, run the faucets until the water is clear to remove any debris. Make sure the drum is empty.

1. Connect the angled ends of the hoses to the inlet valves at the back of the machine (20mm threads). Screw on the couplings

(Continued on the next page)

by hand until they are seated on each gasket.

2. Attach the hose connected to the red (hot) valve to the hot water faucet. Screw on the coupling by hand until it is seated on the gasket. **DO NOT OVERTIGHTEN.**

3. Attach the hose connected to the white (cold) valve to the cold water faucet. Screw on the coupling by hand until it is seated on the gasket. **DO NOT OVERTIGHTEN.**

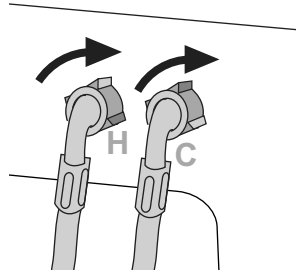

4. Turn on the water faucets and check for leaks.

Secure the Drain Hose

1. Drape the power cord over the washer top.
2. Secure the drain hose to the laundry tub leg or standpipe with a strap or cable-tie.

IMPORTANT!

Replace the inlet hoses after 5-years of use to reduce the risk of hose failure. Record hose installation or replacement dates on the hoses for future reference. Periodically inspect and replace hoses if bulges, kinks, cuts, wear, or leaks are found.

3. Use the U-Clamp (provided) and insert the drain hose into the standpipe or sink. **DO NOT force excess drain hose into the standpipe. There should be only 6" of drain hose in the stand pipe.**

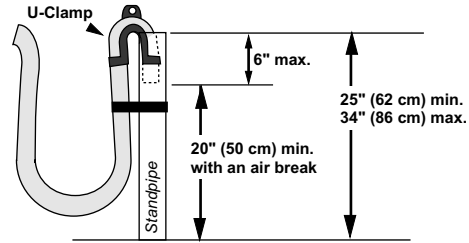

Level the Washer-Dryer

Properly leveling the washer-dryer, prevents excessive noise and vibration.

1. Tilt the machine back, leaning it against the wall.
2. Using a 17mm wrench, tighten the 2 locking nuts to hold each front leg in place. Adjust the legs up or down to ensure the washer is resting solid and does not rock side-to-side or front-to-back when the machine is upright.

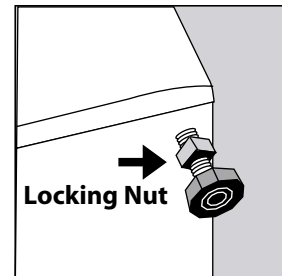

Install Dryer Ducting WD802M

This model must be vented to the outside. Proper routing of the dryer ducting increases drying efficiency and prevents safety hazards.

1. The rigid or flex/metal ducting should slope downward and away from the machine. After determining the shortest, straightest ducting route, cut a 4" diameter hole through the wall to the outside.



Splendide VI-422 Vent Kit

2. Follow the manufacturers instructions to install a louvered vent or flap and tailpiece (sold separately) to the wall.

3. Use duct tape or screw clamps to secure the ducting to the tailpiece and to the vent flange on the back of the machine.

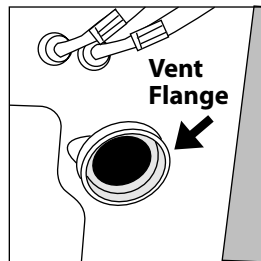

NOTE: The Optional Dryer Lint Filter (see pg. 5)

should ONLY be used in installations with very long duct runs . When this filter is installed, the end-user MUST have easy access to the rear of the machine to clean the filter regularly.

Complete the Installation



- Check the electrical requirements. Be sure that you have the correct electrical supply and the recommended grounding method. (See "Electrical Requirements.")
- Check to be sure all parts are now installed. If there's an extra part, go back through the steps to see which step was skipped.
- Check to be sure you have all your tools.
- Dispose/recycle all packaging materials.
- Check to be sure all water faucets are on.
- Check for leaks around faucets and inlet hoses.
- Plug into a grounded 3-prong outlet.
- Slide the washer-dryer to it's final location and confirm that it's level.
- Read "Owners Manual"

To test and clean the washer, measure 1 to 2 tbsp. of powdered High Efficiency (HE) detergent.

- Pour the detergent into the 'B' compartment in the dispenser drawer
- Select the HOT/WARM wash
- Select the DELICATES cycle
- Then press ON. Allow the washer to complete one full cycle.



Splendide All-Natural Premium HE Laundry Powder, Part No. 1005 - Available from Splendide

 WARNING	
	ELECTRICAL SHOCK HAZARD
	Plug washer-dryer into a grounded 3 prong outlet.
	Do not remove ground prong.
	Do not use adapter.
	Do not use an extension cord.
Failure to follow these instructions can result in death, fire, or electrical shock.	

NOTES:

Theory of Operation

Introduction

The Splendide Front-Loading Washer-Dryer models are designed to wash and dry laundry while taking up the least amount of space. Able to go from wash to dry automatically, they provide exceptional convenience. Using front-loading washing technology, they are more gentle on fabrics while using up to 40% less water than top-loading machines. The Splendide WD802M dries laundry using a traditional vented dryer. Comb-o-matic models dry laundry without a vent - by using condensation.

Water System

The water system consists of the hot and cold water inlet valves and the dispenser distribution system along with a traditional pressure switch.

Water Inlet Valves

The hot and cold water inlet valves are located at the back, top-left of the washer. These valves receive a control signal from the Wash/Rinse Temperature knob to manage the temperature of incoming water. The temperatures are determined by the specific wash temperature selected.

Dispenser Distribution System

All wash and rinse water is introduced into the drum through a Dispenser Distribution System that diverts the incoming water to one or more of the following water inlet modes: Warm/Hot Wash Detergent Dispensing, Cold/Pre-Wash Detergent Dispensing, Bleach Dispensing, Fabric Softener Dispensing. The dispenser drawer has four separate compartments for adding laundry products to the wash load. These compartments are:

- A.** Detergent (Cold Wash/Pre-Wash)
- B.** Detergent (Warm/Hot Wash)
- C.** Bleach*
- D.** Liquid Fabric Softener

All of the water flows through the dispenser assembly. Laundry products are diluted and dispensed automatically at the proper time during the wash cycle. Refer to the "Owners

Manual" that came with the appliance for proper use of laundry aids.



Dispenser Drawer

***NOTE: WDC1024M does not have a Bleach option.**

Pressure Switch

The pressure switch is located in the upper, right-front corner of the washer (below the Wash Timer). This switch senses the water level in the drum. The control signal from the pressure switch is sent to the Wash Timer and is used to determine the amount of water introduced into the drum during the wash cycle.

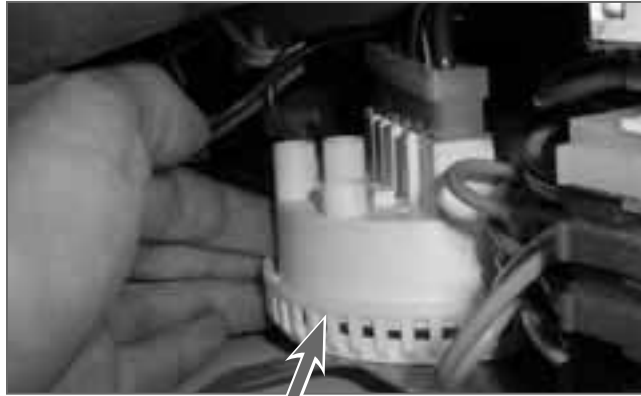

Pressure Switch

Description of Wash/Rinse Temperatures

WASH/RINSE Knob Position	WASH Temperature*		RINSE Temperature*	
	HOT Water Valve	COLD Water Valve	HOT Water Valve	COLD Water Valve
HOT/WARM	Open	Closed	Open	Open
HOT/COLD	Open	Closed	Closed	Open
WARM/WARM	Open	Open	Open	Open
WARM/COLD	Open	Open	Closed	Open
COLD/COLD	Closed	Open	Closed	Open

**NOTE: Actual wash water temperatures will vary depending on the temperature set at the water heater.*

Wash/Dry System

The Wash/Dry System consists of the Module Board, the Wash Timer, the Main Motor, the Pump Motor, and two Dryer Heating Elements.

Module Board

The Module Board is located at the bottom, right-rear corner of the washer-dryer. The module board receives input from the Wash Timer to control drum rotation. If diagnostic tests indicate that the module board is defective, the entire module board must be replaced.



Wash Timer

The Wash Timer is located at the top, right-front corner of the washer-dryer. The Wash Timer sends information to the module board to control drum rotation. The Wash Timer directly controls the dispenser, drain pump, water inlet valves, pressure switch, door locking and unlocking, fan motor and heating element.



Main Motor

The main motor is located at the bottom, rear of the washer and is an infinite speed 0-90 VDC motor that operates at various speeds and directions based on input voltages from the Module Board.

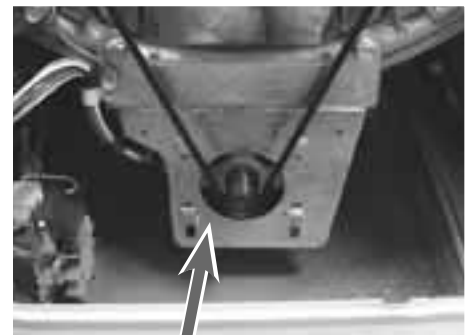

Main Motor

(Continued on the next page)

Pump Motor

A separate Pump/Pump Motor is used to drain the drum (Fig. 3-1). The 120VAC Pump Motor is located at the right, bottom-rear of the machine and is attached directly to the pump. The pump has a filter located at the right, bottom-front of the machine (Fig. 3-2) that allows for the removal of lint and objects like keys and coins that may have passed from the basket.



Fig. 3-1

Drain Pump



Fig. 3-2

Lint Filter

Two Dryer Heating Elements

The two Dryer Heating Elements are located in the heater duct assembly on the top-right of the drum. The Dry Timer provides power to the element in the dry cycle. During the dry cycle:

- **Vented models** (WD802M) take air from the surrounding room, heat it, tumble it through the clothes, and then exhaust it to the outside through a vent.
- **Ventless models** (WDC1024M, WDC1025M/MCEE) require 5 gallons of cold water per hour during the dry cycle. (See below.)

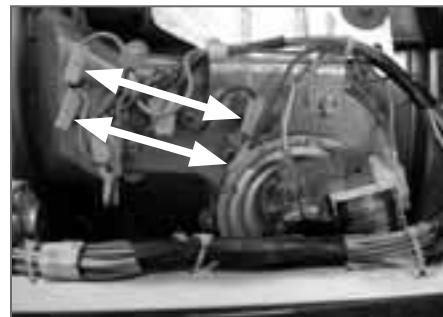

Dryer Heating Elements

How Does Ventless Drying Work?

1. As damp laundry tumbles, the inner drum is heated. Heat draws the moisture out of the laundry in the form of STEAM.
2. Cold water cools the OUTER TUB. The cold surface attracts the warm, saturated air. STEAM passes through the holes in the INNER DRUM to reach the OUTER TUB.
3. When the STEAM hits the cooled surface of the OUTER TUB, it's condensed back into water. The water is then pumped out the drain. Process repeats until clothes are dry.

Door Lock/Switch Assembly

The Door Lock/Switch Assembly is located on the right side of the door opening. The assembly contains a bi-metal operated latching mechanism that will electrically lock the door during a wash cycle or anytime water is in the drum.

Door Lock/Switch Assembly



Suspension System

The drum assembly is held in position with two shock absorbers attached to the bottom sides of the tub assembly. In addition, the drum is suspended from the top frame of the washer with four springs attached to the sides of the case.

Stability for this suspension system is provided by two concrete counter weights. One is located at the top and one at the bottom-front of the outer drum.

Springs

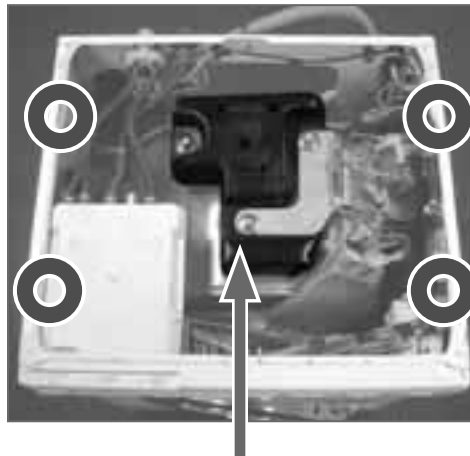

Top Counter Weight

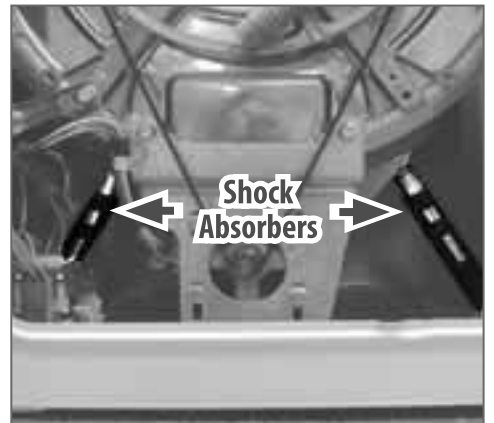

Customer Interface / Cycle Selection System

The Customer Interface / Cycle Selection System consists of the Control Panel Assembly along with the Cycle Selector, option buttons, and Wash/Rinse Temperature and Dry Time Selectors.

Control Panel Assembly

The Control Panel Assembly (Fig. 3-3) contains all the buttons and switches for the user to operate the washer-dryer. This interfaces what the consumer commands to the machine.

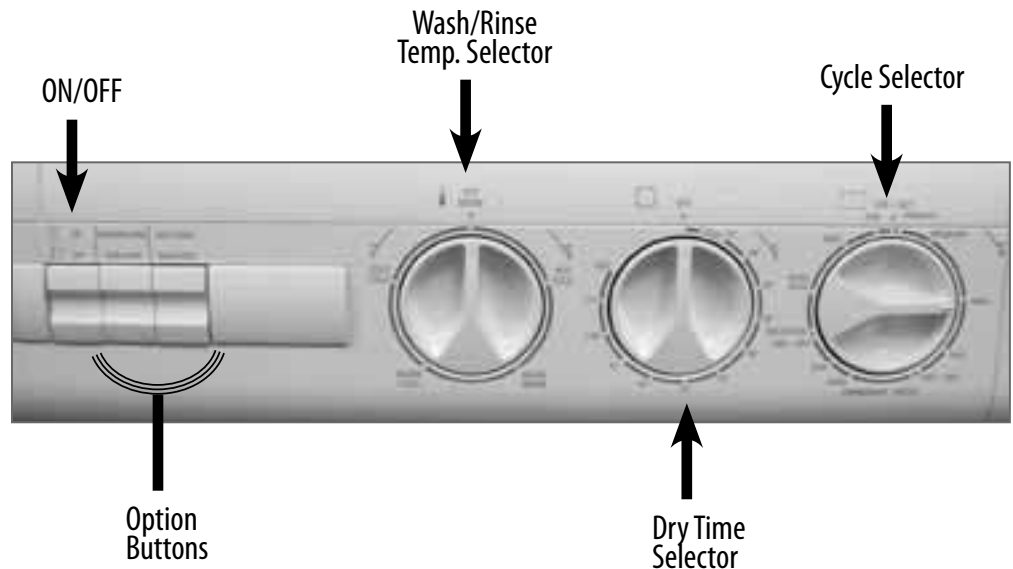

Fig. 3-3

Description of Control Panel Buttons & Knobs

ON/OFF Button- Leave the ON/OFF button in the OFF (out) position while setting the controls, then press ON (in) to start the program.

Option Buttons - Use these buttons to modify the wash or dry cycle (see "Description of Option Buttons")



Wash/Rinse Temperature Selector - Choose a wash/rinse temperature combination by turning the knob to the desired selection. Refer to the garment label and choose the warmest water safe for the fabric.

Dry Time Selector - Choose a dry time by turning the knob to the desired selection. Choose from No Dry ("OFF") up to 120 min. This knob moves, or "counts-down" during the dry cycle.

Cycle Selector - Choose a wash cycle or dry cycle by turning the knob to the desired cycle. Each cycle is designed for different types of fabric and soil levels. This knob moves, or "counts-down" during the wash cycle.

(Continued on the next page)

Description of Cycle Selector Options

Rinses and Spins - Use a Rinse cycle to get a rinse and spin only. A rinse is useful for loads that need rinsing only or for adding fabric softener to a load. Use the spin cycles to remove moisture from fabrics or to drain water from the drum.

Description of Option Buttons

You can customize the wash or dry cycle by adding an OPTION or combination of options to your cycle selection. You can add or change the options at any time during operation.

Medium Spin/High Spin - Pressing this button will reduce the spin speed to 800 rpm

Half Heat/High Heat - Pressing this button will reduce the temperature during the dry cycle

Description of Preset Wash Cycles

Regular Wash – Use the Regular cycles to wash loads of sturdy, colorfast fabrics and normally to heavily soiled garments. These cycles combine fast speed tumbling and an extra high spin speed (1000 RPM) to shorten dry times.

- PREWASH – Use this cycle to wash heavily soiled garments.
- REGULAR – Use this cycle to wash normally soiled garments.

Permanent Press Wash – Use the Permanent Press cycle to wash loads of no-iron fabrics such as sport shirts, blouses, casual business clothes, permanent press blends, linens, and other synthetic fabrics. These cycles combine medium speed tumbling and a medium-speed spin (800 RPM) for reduced wrinkling of synthetic fabrics.

- PERMANENT PRESS – Use this cycle to wash normally to heavily soiled garments.

Delicates Wash – Use the Delicates Cycles to wash sheer fabrics, silk, wool, lingerie and other hand washable items. These cycles combine variable speed tumbling and a low spin speed (450 RPM) for gentle fabric care. (Check the label instructions to make sure that the garment is washable.)

- DELICATES – Use this cycle for delicate fabrics.
- KNITS WOOL – Use this cycle to clean washable woolen garments and other hand washables.

How to Set a Wash Cycle ONLY*

1. With the machine OFF, select a Wash Cycle
2. Set the Dry Time knob to "OFF"
3. Press "ON"

**See next page for 'How to Set a Wash Through Dry Cycle' and 'How to Set a Dry Cycle ONLY!'*

Description of Preset Dry Cycles

OFF-DRY - Use this high heat cycle to dry sturdy, colorfast fabrics like towels socks and jeans. (Press the Half Heat/High Heat button to use a medium heat cycle to dry certain blouses and casual business clothes.)

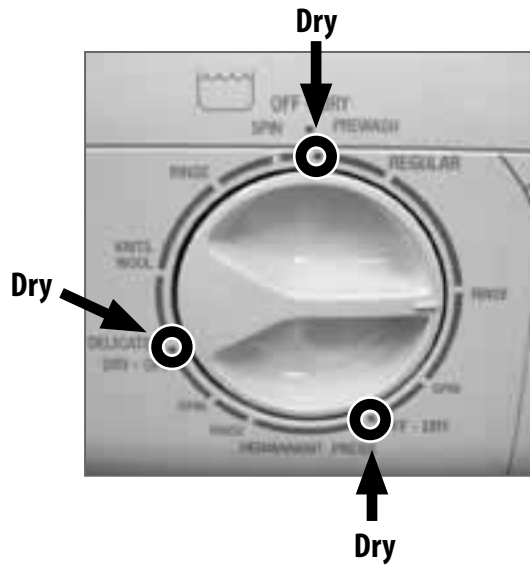

How to Set a Wash Through Dry Cycle

1. With the machine OFF, select a wash cycle
2. Set the Dry Time knob to the desired time
3. Press "ON". When the wash cycle is finished, the machine will automatically start drying in the preset cycle.

How to Set a Dry Cycle ONLY

1. With the machine OFF, select a Dry Cycle (see above)
2. Set the Dry Time knob to the desired time
3. Press "ON"

Preset Wash/Dry Cycles Chart

Type of Fabric	Cycle Selector Knob	Detergent for Wash	Fabric Softener	Bleach (Not Available on Cold/Cold)	Options Available	Total Length of Cycle**	Description of Wash Cycle**
Exceptionally soiled whites/colorfast fabrics (Sheets, tablecloths, etc.)	PREWASH	●	●	●	Medium Spin/ High Spin	67 min	42 min. wash cycle, 3 rinse cycles, and spin cycle
Whites/colorfast fabrics	REGULAR	●	●	●	Medium Spin/ High Spin	56 min	30 min. wash cycle, 3 rinse cycles, and spin cycle
Rinse Cycles	Rinse	Fabric softener is automatically dispensed during the last rinse			Medium Spin/ High Spin		
1000 RPM spin	Spin				Medium Spin/ High Spin		
Drying Cycle or OFF	OFF-DRY				Half Heat/ High Heat	0-120 min	Drying cycle for cotton fabrics
Colorfast synthetics (Baby linen, etc.)	PERMANENT PRESS	●	●		Medium Spin/ High Spin	38 min	18 min. wash cycle, 2 rinse cycles, and spin cycle
Rinse Cycles	Rinse	Fabric softener is automatically dispensed during the last rinse			Medium Spin/ High Spin		
800 RPM spin	Spin				Medium Spin/ High Spin		
Drying Cycle or OFF	Dry-Off				Half Heat/ High Heat	0-120 min	Drying cycle for permanent press fabrics
Delicate color synthetics	DELICATES	●	●			23 min	12 min. wash cycle, 2 rinse cycles, and spin cycle
Kit/Wool Washables	KNITS/WOOL	●	●			17 min	6 min. wash cycle, 2 rinse cycles, and spin cycle
Rinse Cycles	Rinse	Fabric softener is automatically dispensed during the last rinse					
450 rpm	Spin						
Drying Cycle or OFF	OFF-DRY				Half Heat/ High Heat	0-120 min	Drying cycle for delicate fabrics

NOTE: Some options cannot be added to some cycles. Always follow the washing and drying instructions found on the clothing tag.

**Wash cycle times will vary according to water pressure, load size and fabric type. Dry cycles include a 12-minute cool down.

Automatic Routines

The following are routines that the washer-dryer will follow out automatically during the wash, spin, rinse and/or dry cycles.

Door Locking / Unlocking Routines

Door Locking Summary - The Door Locking Routine will only start if the door is securely closed and the Door Switch contact is CLOSED.

1. The Door Switch is energized whenever a wash cycle is started.
2. During the next few seconds, the contacts on the door switch are checked by the Wash Timer. Then, the cycle will begin.

Door Unlocking Summary - Unlocking will occur ONLY under these conditions:

1. The Main Motor speed equals "0"
2. There is no water in the drum
3. The wash cycle is finished
4. The Cycle Selector is on an 'OFF-DRY' position

IMPORTANT!

- The door WILL NOT open while a wash cycle is in progress.
- The door WILL STAY LOCKED for approximately 1-2 min. after the wash cycle is complete.
- To interrupt a wash cycle and open the door, advance the Cycle Selector knob to a Spin position. Wait for the water to drain from the drum. When there is no water left in the drum, advance the knob to an OFF-DRY position. Wait 1-2 minutes for the door to unlock.

DO NOT attempt to open the door while the door lock is still engaged. If you do, the handle could break and replacement costs would not be covered under the Warranty.

Wash Quality Routines

Drain and Spin Routines - During the Drain and Spin cycles, the water level is checked continuously. Normal Drain and Spin will occur until the Pressure Switch senses no water in the drum.

Impulse Spin Technology (IST) - During the Spin cycle the drum will rotate at varying speeds before reaching high spin (instead of a constant pace). This routine optimizes rinse efficiency and drying uniformity - clothing comes out with less creasing and wrinkling.

Automatic Balance Routine

Automatic Balance Routine Summary - An unbalanced load can cause excessive noise and vibration. The Automatic Balance Routine occurs during the distribution ramp (while the basket spin is accelerating from 40 to 600 rpm). At 600 rpm the motor is decelerated and the rate of deceleration is monitored by the Module Board. The motor is then ramped up to 600 rpm and shut off. The rate of deceleration is monitored again and compared to the first deceleration rate. Based on this comparison, the Module Board can determine whether an unbalanced condition exists or not.

- If the Module Board does not sense an unbalanced condition, the ramp will continue.
- If the Module Board senses an unbalance condition, the Main Motor will rotate slowly back and forth for the remainder of the cycle.

NOTES:

Accessing the Components

Component Locations

Follow the instructions in this section to gain access to the following components.

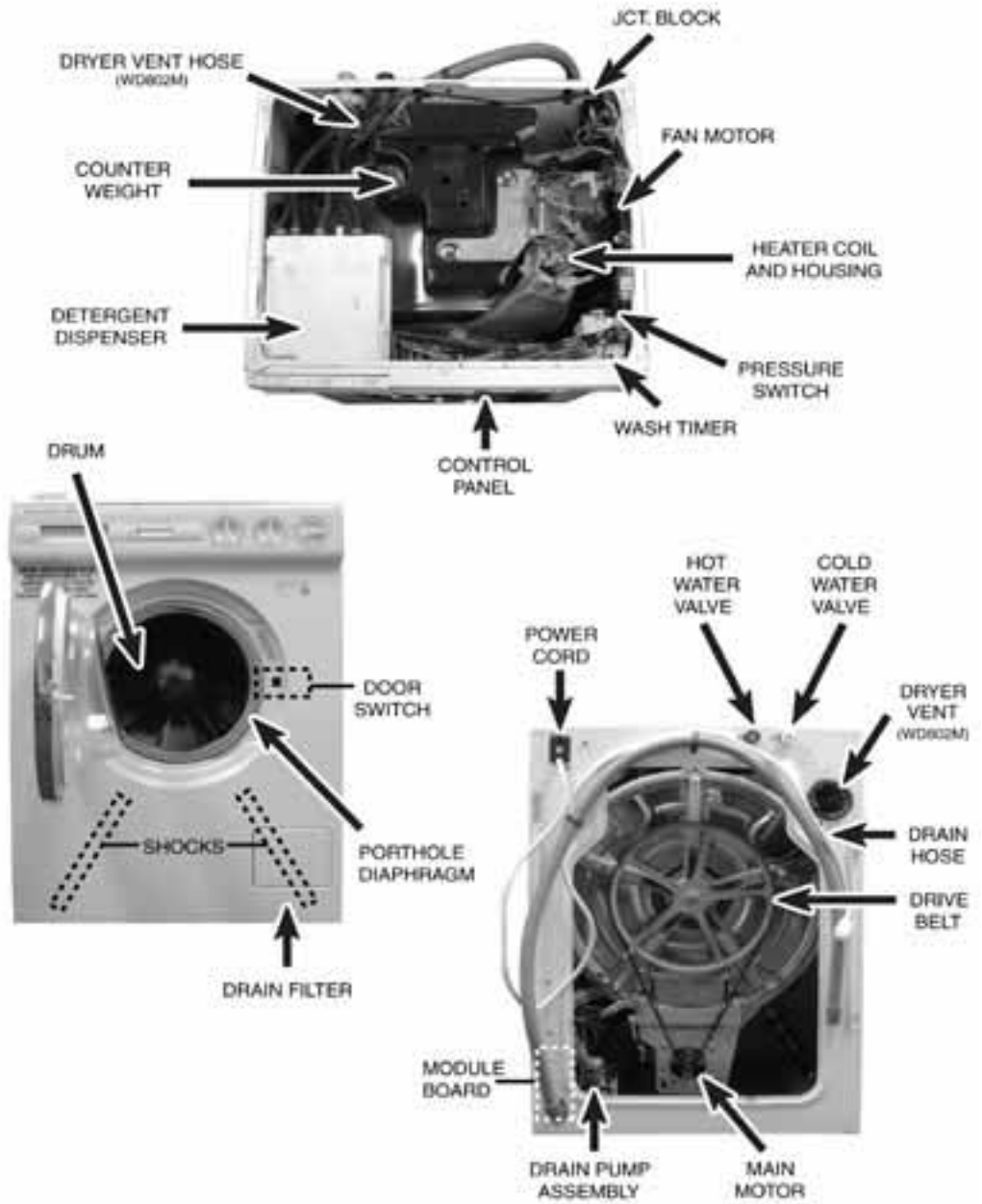

Required Tools

To access components in this washer-dryer, you'll need Metric and Standard sockets of various sizes, a Flat Head Screwdriver, and a Phillips Head Screwdriver.

Top Panel / Wash Timer / Other Control Panel Components

Access to the Control Panel requires that the top of the washer be removed.

Removing the Washer-Dryer Top

Four 7mm screws secure the main top at the back of the washer-dryer. (Below) Remove these screws and lift straight up on the rear of the main top, then slide forward.

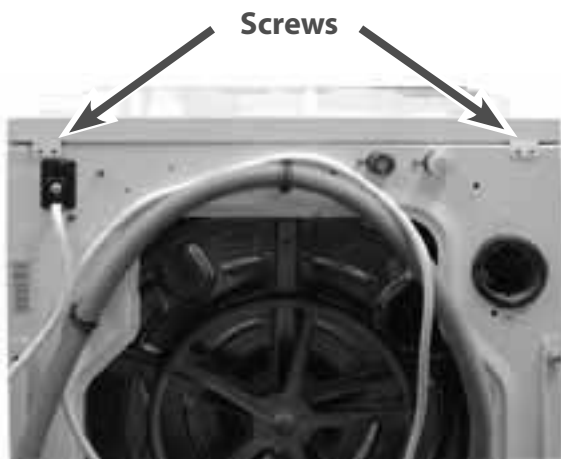

Removing the Knobs

Remove the knob by pulling straight out. If you need to use pliers, make sure to use a shop rag as a buffer, so the knob does not get damaged. (Right)



Removing the Wash Timer

Two Phillips Head screws secure the wash timer to the case. (Fig. 4-1). Remove these screws.



A ground wire connects to the wash timer. Detach this wire by pulling straight out.

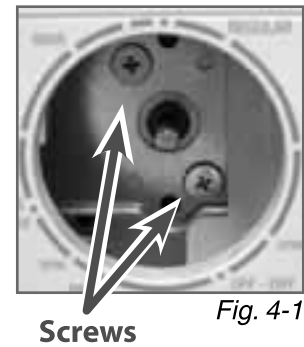

Fig. 4-1

Five large, color-coded plugs and two wires connect the wash timer to the wiring harness. First, mark all connections, so the plugs and wires are attached correctly when reinstalled.

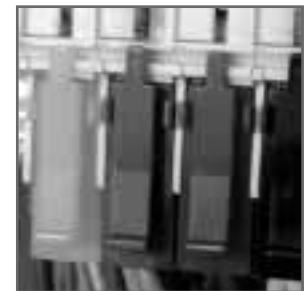

Fig. 4-2

Remove the plugs by pressing down on the five tabs on each side using a flat blade screwdriver (Fig. 4-2).

Finally, detach the two wires that hold the wash timer to the case (Fig. 4-3) by pulling straight out.



Fig. 4-3

Removing Dry Time/ Water Temp. Selectors

Two Phillips Head screws secure each Selector (Below).
Remove these screws.

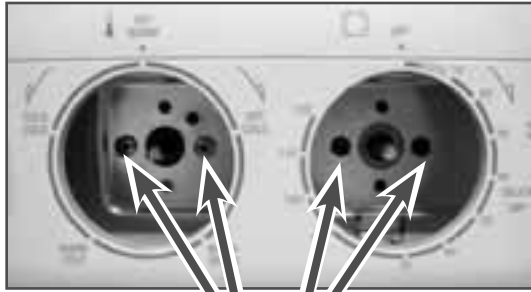

Screws

Removing the Control Panel

Seven Phillips Head Screws (Below) connect the Control Panel to the case. Remove these screws, then lift the entire panel straight off.



Fig. 4-4

Six* wires connect the Water Temperature Selector (Fig. 4-4) to the wiring harness. Six wires connect the Dry Time Selector (Fig. 4-5) to the wiring harness.

First, mark all connections, so these wires are attached correctly when reinstalled.

Detach these wires by pulling straight out.



Fig. 4-5

**NOTE: The WDC1025MCEE Water Temperature Selector is connected by four wires (instead of six).*

Door / Door Switch / Porthole Diaphragm

Open the Door to access the Door, Door Switch and Porthole Diaphragm.

Removing the Door

Remove the two, Phillips screws that secure the door to the door hinge. (Fig. 4-6)

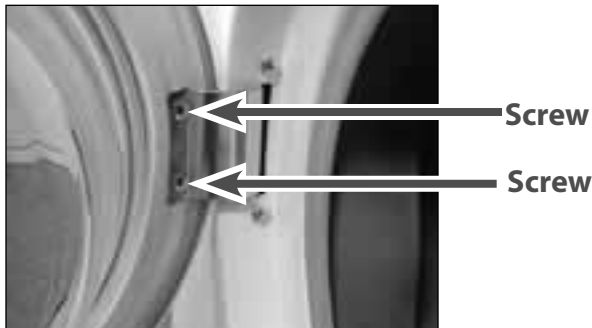

Fig. 4-6

switch is secured to the washer front panel with two, Phillips Head screws (Fig. 4-8). Once these screws are removed, the door switch can be pulled out so the wires can be removed. Then, detach the five wire connections from the door switch by pulling straight out.

Reinstall the retainer wire by easing it back on to the front of the diaphragm with the help of two flat-head screwdrivers (see right).



Removing the Door Switch



Fig. 4-7

If the washer top cannot be removed, access to the door switch requires that the porthole diaphragm and retainer wire be eased back from the front of the washer. To do this, grab the edge of the diaphragm with both hands and pull up and out (4-7). If there's resistance, try a different area until you find a spot that's looser.



Remove enough of the diaphragm to gain access to the door switch behind the washer dryer front panel (see below). The door

switch behind the washer dryer front panel (see below). The door

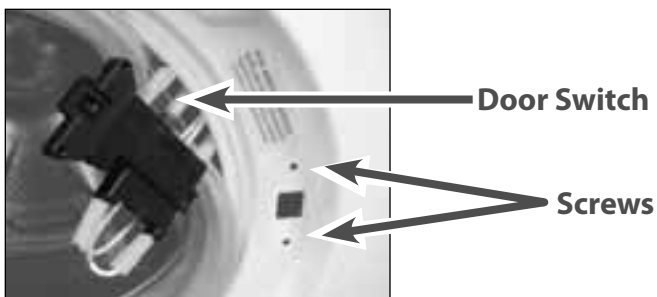

Fig. 4-8

Removing the Porthole Diaphragm



Fig. 4-9

Plastic Wire Tie

Using a flat-head screwdriver, gently ease the diaphragm off of the heater housing (Fig. 4-9).

Next, locate and loosen the 8mm bolt that holds the clamp to the drum (Fig. 4-10). The diaphragm can now be removed completely from the tub. Pull the diaphragm off the drum and out of the machine through the front porthole.

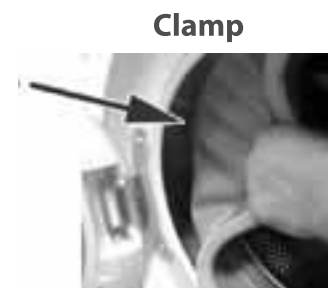

Fig. 4-10

Detergent Dispenser Assembly / Water Valves

Access to the Detergent Dispenser and Water Valves requires that the top of the washer be removed.

Removing the Dispenser Assembly

Begin by removing the top, then use two hands to pull the dispenser drawer completely out of the housing. (Fig. 4-11) Remove the four Phillips Head screws securing the front of the detergent dispenser assembly to the top of the Control Panel (Fig. 4-12).

Fig. 4-11



Fig. 4-12

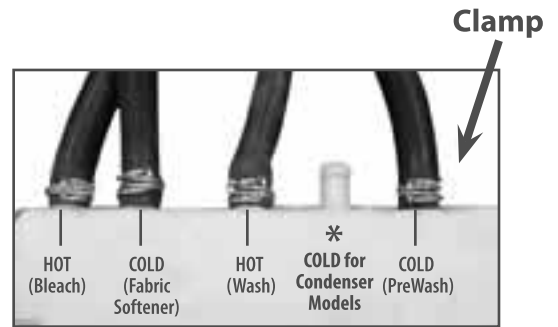

Fig. 4-13

Squeeze to remove the four clamps securing the detergent dispenser assembly to the fill hoses. (Fig. 4-13). Next, squeeze to remove the clamp that holds the large hose to the bottom of the dispenser assembly (see right).



Once removed, the hoses can be pulled straight off. Now you can lift the detergent dispenser assembly out.

Removing the Water Valves

Begin by removing the top. Remove the two Flat Head screws that secure the valves to the back of the machine (Fig. 4-14).

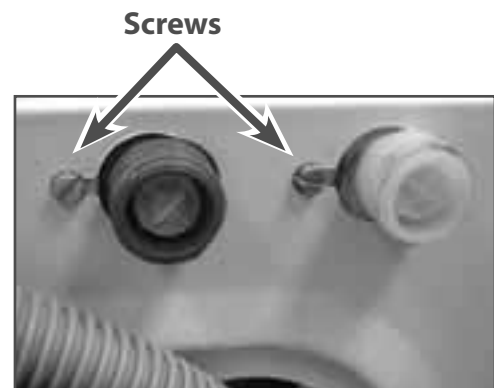

Fig. 4-14

(Continued on the next page)



Fig. 4-15

The Hot Water Valve (Red) is connected with one hose and two wires. The Cold Water Valve (White) is connected with two hoses and four wires (Fig. 4-15). *NOTE: The WDC1024M, WDC1025M and WDC1025MCEE Cold Water Valve is connected by THREE hoses and SIX wires (instead of two hoses and four wires.)



Remove the hoses by pulling straight out. First, mark all connections, so the hoses and wires are attached correctly when reinstalled. Detach these wires by pulling straight out.

IMPORTANT!

It's very important to note the orientation of the wiring on the valves for re-installation. If the wiring is switched the water temperatures will be incorrect, and on condenser machines, the dry cycle will not operate correctly.

Pressure Switch

The Pressure Switch is located on the top-right, front corner of the machine. The pressure switch can be accessed once the top is removed.

Removing the Pressure Switch



The Pressure Switch is attached to a metal plate behind the Dry Time Knob. To release the metal plate, first remove the Dry Time knob by pulling straight out. Next, using a small screwdriver, bend the

three tabs (Fig. 4-16) inwards.

Using pliers, snip the plastic wire tie that connects the metal plate to the wiring harness.

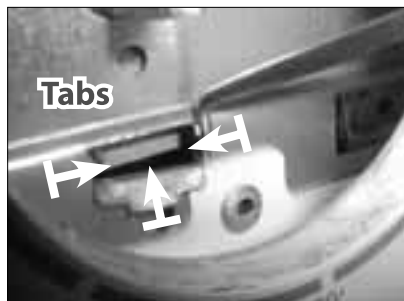

Fig. 4-16

Using pliers, squeeze the clamp to disconnect the black hose from the bottom of the pressure switch (Fig. 4-17). Be careful not to pull up on the hose too much, or it may become disconnected from the

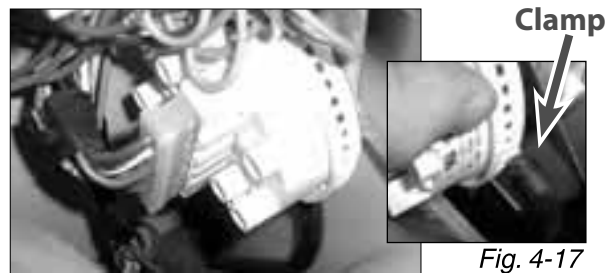
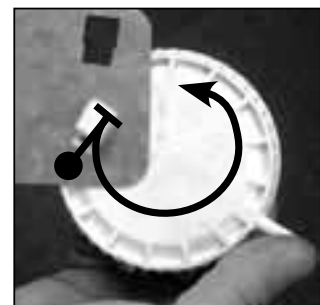

Fig. 4-17

bottom of the drum. Next, pull straight out (Above) to remove the Wire Harness connector from the pressure switch.

Finally, to detach the Pressure Switch from the metal plate, push it upwards, then rotate it clockwise (Right).



Fan Motor / Thermostats / Fuse Link & Heater Coil

The Fan Motor, Thermostats, Fuse Link and Heater Coil are located on or in the Heater Duct Assembly that sits on the drum and are located on the top, right side of the machine. They can be accessed once the top is removed.

Removing the Fan Motor

Disconnect the two wires that are attached to the fan motor. Next, remove the four 7mm screws that secure the fan motor to the Heater Duct Assembly. (Fig. 4-18)

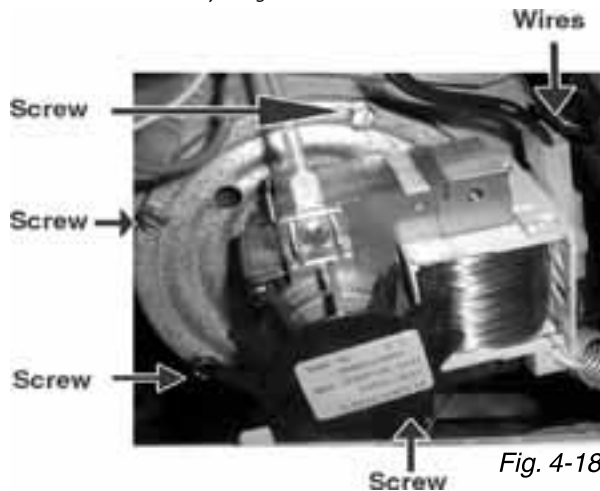

Fig. 4-18

Remove the 11mm nut with LEFT-HANDED threads (Below) that secures the impeller to the motor shaft. Lift the impeller straight off the fan motor shaft. You may need to use a punch.



NOTE: Make sure the impeller does not touch the gasket when re-installed. If the gasket is damaged it will need to be replaced.

Removing the Fuse Link



Detach the two wires connected to the Fuse Link (Fig. 4-19, A) by pulling straight out. Using a Phillips Head screwdriver, remove the screw that secures the Fuse Link to the Duct Assembly. Lift the Fuse Link off the Heater Duct Assembly.

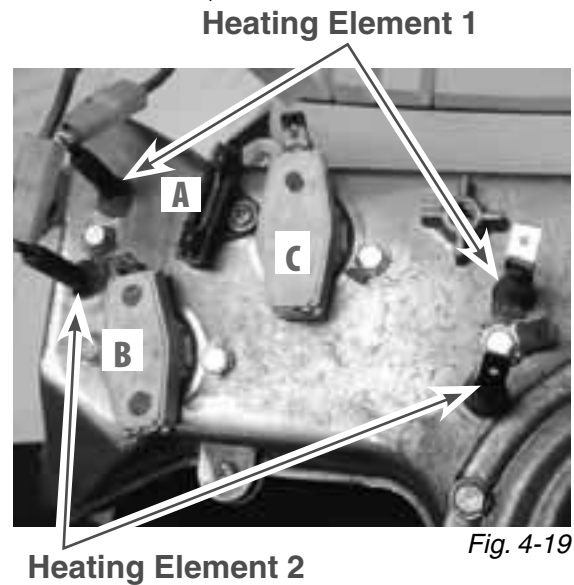

Fig. 4-19

A) Fuse Link

B) 110° F Thermostat (Marked w/two red dots)

C) 88° F Thermostat (Marked w/one red dot)

Removing the Thermostats

This machine has two Thermostats (Fig. 4-19, B and C). The Thermostat is secured to the Heater Duct Assembly with two 7mm nuts (or one 7mm nut and one Phillips Head screw) - one on each side. Two wires connect each Thermostat to the Wiring Harness.

To remove a Thermostat, detach the two wires by pulling straight out. Remove the two nuts (or one nut and one screw). Finally, pull the Thermostat straight out of the Duct Assembly.

(Continued on the next page)

Removing the Duct Assembly

First, mark all connections, so these wires are attached correctly when reinstalled. Detach these wires by pulling straight out. Remove the two 13mm nuts that secure the Heater Duct Bracket to the Counter Weight (Fig. 4-20).



Fig. 4-20



Carefully cut the plastic wire tie that secures the diaphragm to the lip of the heater housing (Left).

Removing the Duct Assembly



Using a Phillips Head Screwdriver, remove the five Phillips Head Screws that hold the Heater Duct Assembly together (Left). Carefully pry the two pieces of the housing apart.

Once apart, remove the two 7mm screws that secure the Heater Coil to the housing (Fig. 4-22). Pry the Heater Coil out of the Heater Duct Assembly - use care not to damage the Housing.



Screws

Fig. 4-22

IMPORTANT! About Condenser Models

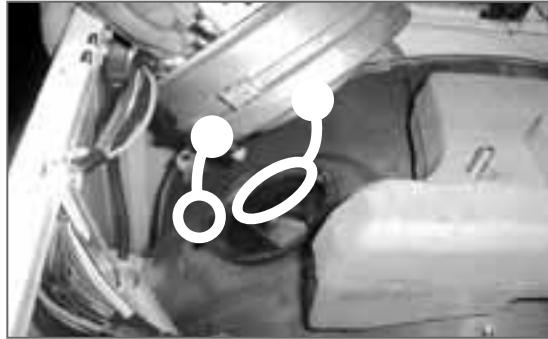

Fig. 4-21

There are two gaskets on the heater housing assembly. When reinstalling the assembly, you must align these two gaskets with the corresponding holes. (Fig. 4-21) After carefully aligning the gaskets with the holes, apply downward pressure as you tighten the two nuts that secure the heater housing bracket to the counterweight. (Right) If the gaskets are not seated correctly, the unit will leak.



IMPORTANT! About Vented Models



Vented models have a rubber spacer on the heater housing that assures clearance for adequate airflow to the fan. Check that this spacer is properly installed before reassembly.

Drain Pump / Pump Filter

*The Drain Pump is located at the lower, right-rear of the machine.
You'll need to remove the Lower Panel to access the Drain Pump and Pump Filter.*

Removing the Drain Pump

With any residual water drained from the unit, gently tip the washer onto its right side.

To remove the Bottom Panel, remove the four screws that secure the sheet metal cover to the bottom of the washer. Remove the metal cover by sliding it towards the back.

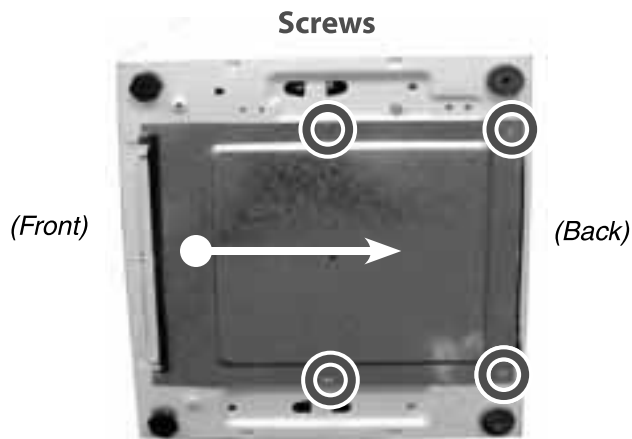

The Drain Pump is connected to hoses that are secured with two clamps and two 7mm screws (Fig. 4-24). Before you disconnect the hoses, note their orientation and place a towel under them to catch any water left inside.

After removing the screws, unclamp the hoses from the Drain Pump and remove the entire pump assembly.

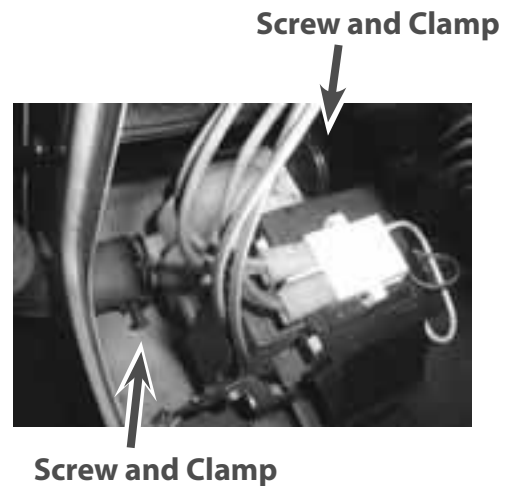

Remove the two 8mm bolts that secure the Drain Pump to the cabinet. (Fig. 4-23).

(Pump Filter on the next page)

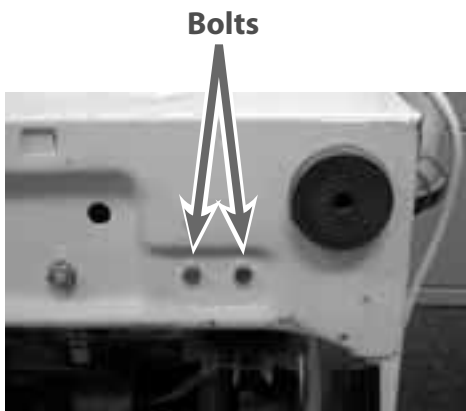

Fig. 4-23

Removing the Pump Filter

The Pump Filter is located in the lower, right-front of the appliance. With any residual water drained from the unit, gently tip the washer on its right side and remove the sheet metal cover on the bottom (See Removing the Drain Pump).

Two clamps secure two hoses to the Pump Filter (Fig. 4-24). Before you disconnect the hoses, note their orientation and place a towel under them to catch any water left inside. Next, unclamp the hoses from the Pump Filter.

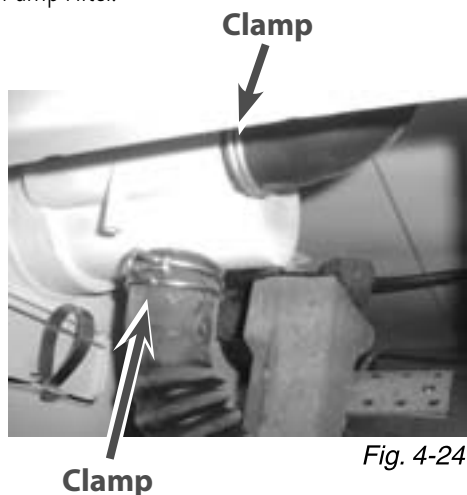

Fig. 4-24

Using a Phillips Head screwdriver, remove the two screws that secure the Pump filter to the front of the washer case (Below).



To Clean Out the Filter

First, place a towel beneath the filter area to catch any water that may come out.



With the machine empty and OFF, turn the Program Selector Knob to the start of the first spin cycle (Above). Next, Push the power button ON (In). The drum will begin spinning. *NOTE: You'll have 5 minutes to complete this task before the pump begins cycling.*



Open the Filter Door by pressing on the left side (Left). Turn the filter counter-clockwise (Below) to release it from its housing. Pull it out.



NOTE: If you have difficulty, the rubber handle ends of pliers or a similar tool can be used to unscrew or tighten the filter.

Clean the filter under running water to help remove all lint and debris. Replace the filter by sliding it back into its housing and turning clockwise to tighten securely. Finally, close the service door and press the Power button OFF (Out).



Back Panel / Main Motor / Motor Brushes

The Main Motor can be accessed once the back panel has been removed.

Removing the Back Panel

Remove the three, 7mm screws that secure the panel to the back of the cabinet (Fig. 4-25) Now lift the panel off.



Fig. 4-25

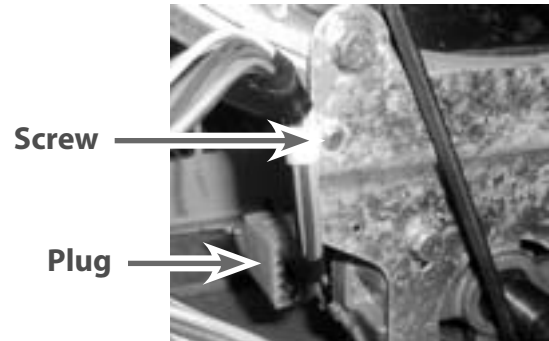

Next, Remove the 7mm screw that secures the wire harness to the motor bracket (Above). A plug connects the Wire Harness to the Motor (Above). Unplug it by squeezing the two tabs on both the top and bottom of the plug and pulling straight out. Finally, lift the Main Motor out of the cabinet.

Removing the Main Motor

After removing the Back Panel, remove the Drive Belt. Next, remove the two 13mm mounting bolts that secure the motor to the tub. (Below)

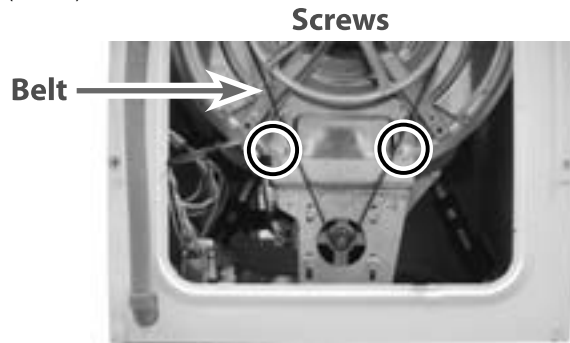

Removing the Motor Brushes

Remove the two, 5.5mm screws that hold the brush in place (Below). Lift the brushes out of the motor assembly.

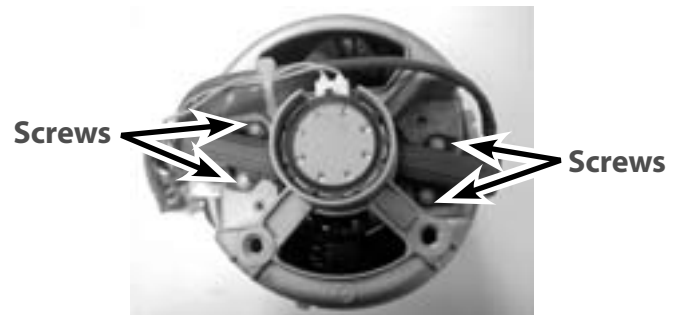

Remove the 17mm bolt that secures the motor bracket to the right-hand shock (Right).

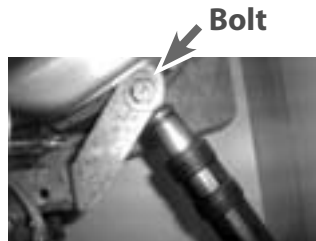

Module Board / Shock Absorbers

The Module Board and Shock Absorbers can be accessed once the Back Panel has been removed.

Removing the Module Board

Remove the three, 7mm screws that secure the panel to the back of the cabinet (Fig. 4-25). Now lift the panel off.

15 wires (4 plugs) connect the Wire Harness to the Module Board. Directly above the Module Board, a plastic clip secures these wires to the rear of the case. Open the clip (Right) and pull the wires away from the clip to allow more slack when removing the Module Board.



The Module Board sits in a black plastic housing. To remove the Module Board from the housing, first pull the large tab outward (Fig. 4-26). Then, push the board forward and completely out of the housing.



Fig. 4-26



Module Board

Removing the Shock Absorbers

The tub is held in position by two Shock Absorbers. After removing the Back Panel (See Fig. 4-25), follow these steps to remove the Shock Absorbers.



Remove the bolts that secure the shock absorbers to the tub (Left) using a 17mm socket.

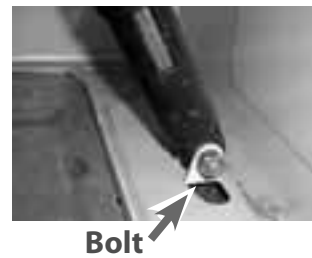

Remove the bolts that secure the shock absorbers to the bottom of the case (Left) using a 17mm socket.

Component Testing Procedures

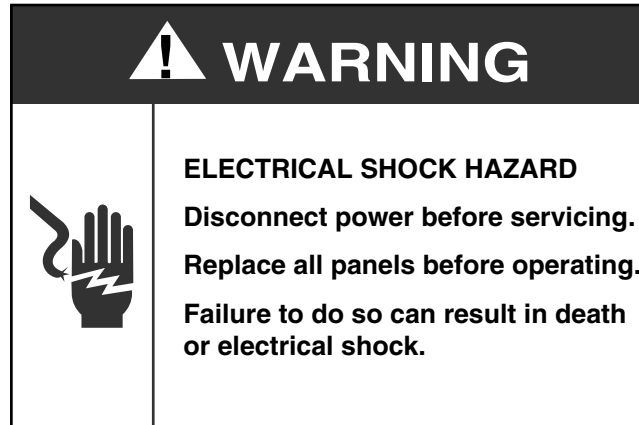

Introduction

Before testing the components, **ALWAYS**:

- Make sure that the power cord is firmly plugged into a live circuit with the proper voltage.
- Check for a blown household fuse or circuit breaker that has tripped.
- Make sure that the dryer vent is properly installed and clear of lint obstructions. (WD802M Only.)

When testing, follow these instructions:

- Resistance tests **MUST** be made with the power cord unplugged from the outlet, and the wire connector removed from the Module Board.
- All tests should be made with a VOM (volt ohmmeter) or DVM (digital volt ohmmeter) having a sensitivity of 20,000 ohms-per-volt DC or greater.
- **BEFORE** replacing any component, **ALWAYS** check for wire connectors that are not pressed tightly into their terminals. Tests **MUST** be made with **ALL** connectors attached. Look for broken or loose wires, failed terminals, or wires that are not pressed into their connectors far enough.

Your Test Results

If the readings you obtain with the following tests match the specified range, the tested component is operating correctly.

If the readings you obtain are not in the specified range, call Splendide Service at 1-800-356-0766 (503-655-2563) ext. 5 for further assistance. **Have the Model and Serial Number of your machine ready when you call.**

1. Door Switch Testing

Door Switch Test Points are located on the Door Switch. (See "Component Locations").

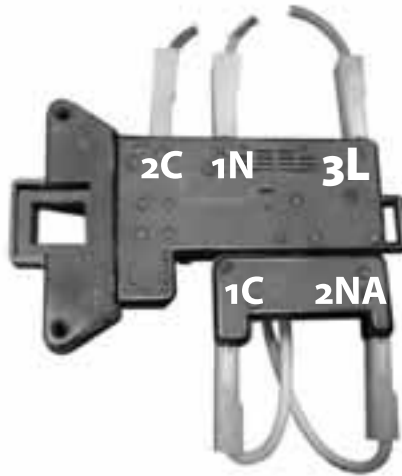

Before Performing Below Tests

Always place a jumper wire between pins 2C and 3L. If the unit works, the door switch needs to be replaced.

If the unit doesn't work

To check the Door Switch for proper operation during a wash cycle, the door must be locked:

1. Begin with the machine OFF. Using the Program Selector, select any wash or dry cycle.
2. Next, press the ON/OFF button "in" to the ON position. You'll hear the door lock engage.
3. Now, unplug the washer-dryer from the wall outlet and check for continuity at the following points. **NOTE: Because the washer-dryer will automatically unlock, the reading must be taken within 1-minute after the washer-dryer is unplugged.**

Wash Cycle Operation	Test Points	Reading
Unlocked Door	2C to 3L	INFINITY (OL)
Locked Door	2C to 3L	0 ohms

To check the Door Switch for proper operation during a dry cycle:

1. Remove the Door Switch (See "Accessing the Components").
2. Slide the plunger in to imitate the door is closed and check for continuity at the following points.

Dry Cycle Operation	Test Points	Reading
Unlocked Door	1C to 2NA	0 ohms

2. Power “in” from the Surge Protector Test

Surge Protector Test Points are located on both the Surge Protector and on Pins 10 & 11 on the Circuit Board (See “Component Locations” and “Connector Locations on the Module Board”)

Surge Protector

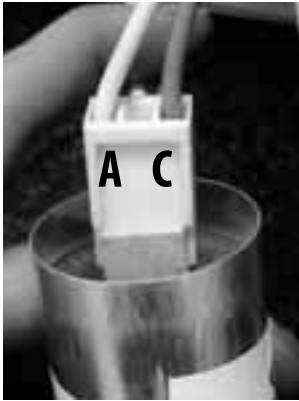

Pins 10 & 11 on Module Board

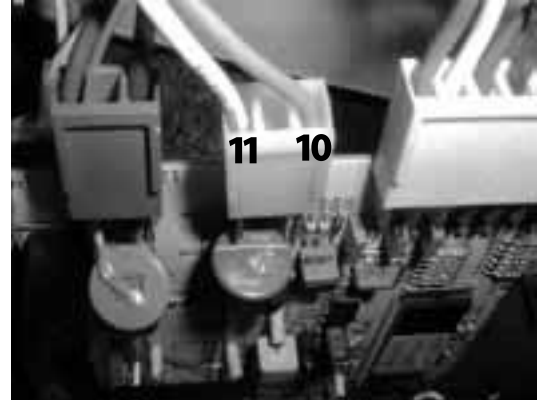

Fault Codes: N/A

	Test Points	Reading
Surge Protector to Module Board	A to Pin 11	1.0 ohms
Surge Protector to Module Board	C to Pin 10	0 ohms

3. Pressure Switch Test

Pressure Switch Test Points are located on the Pressure Switch (See "Component Locations")

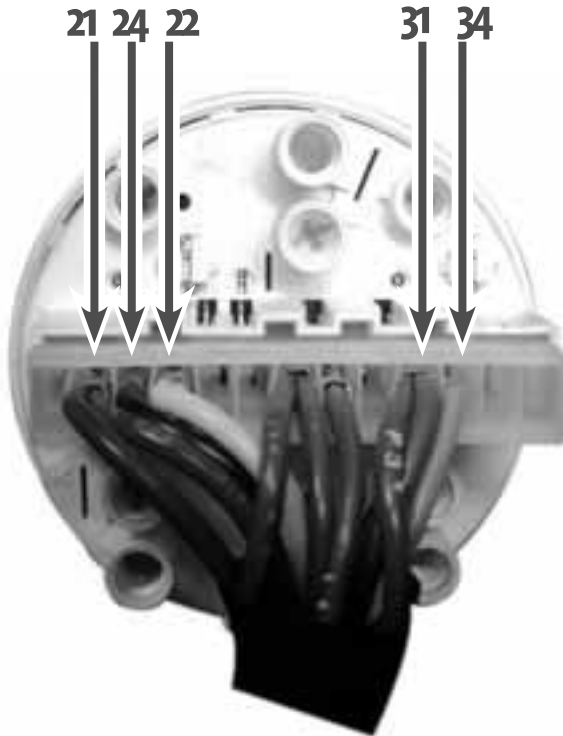

	Test Points	Reading
Water Level Empty	21 to 22	0 ohms
Water Level Full	21 to 24	0 ohms
Water Level Overfull	31 to 34	0 ohms

4. Fan Motor Test

Fan Motor Test Points are located on the Fan Motor (See "Component Locations").

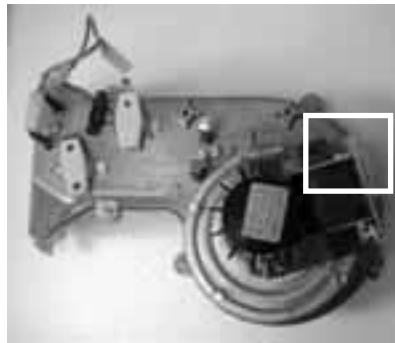

Fan Motor Test Points

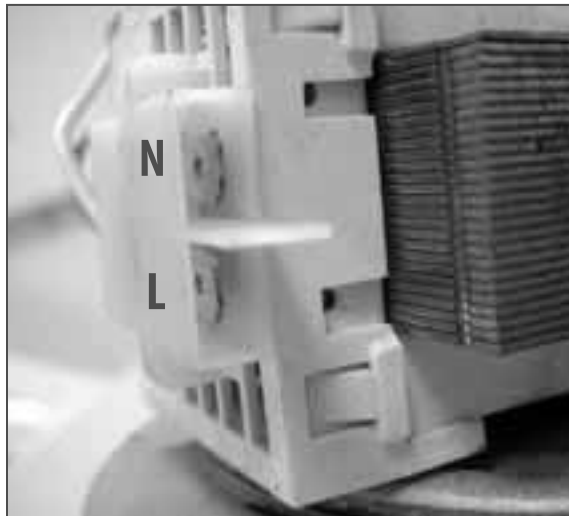

Test Points	Reading
L to N	7.5 ohms
Voltage across L and N	120 VAC (With washer-dryer ON in Dry cycle)

5. Heater Coil Test

Heater Coil Test Points are located on the Heater Coil Housing (See "Component Locations").

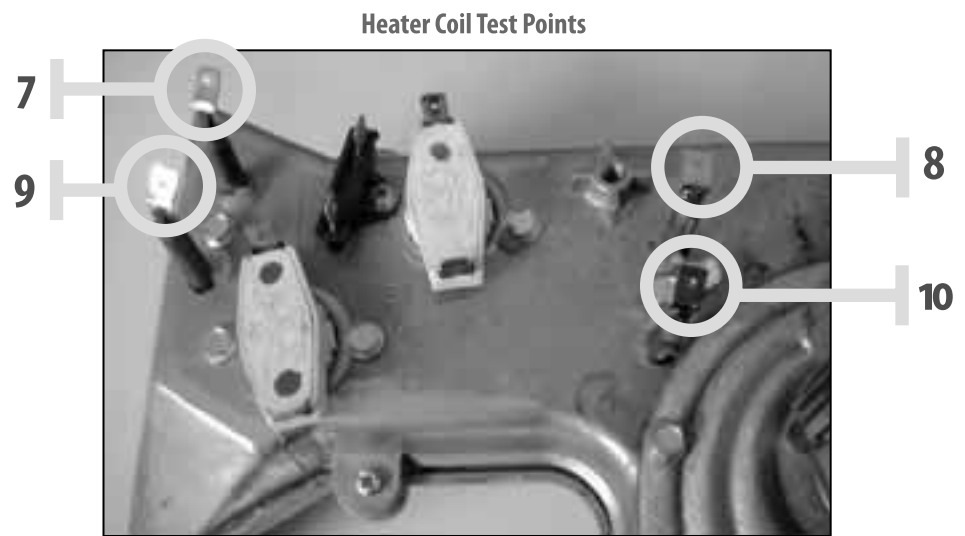

Test Points	Reading
7 to 8	20 ohms
9 to 10	20 ohms

6. Fuse Link and T-Stats Tests

Fuse Link and T-Stat Test Points are located on the Heater Coil Housing (See "Component Locations").

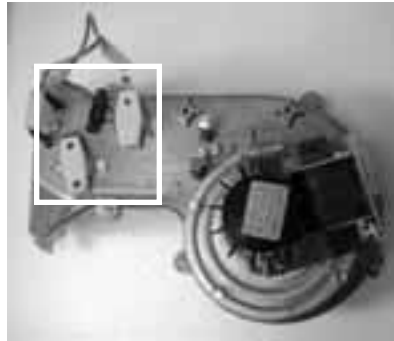

Fuse Link and T-Stat Test Points

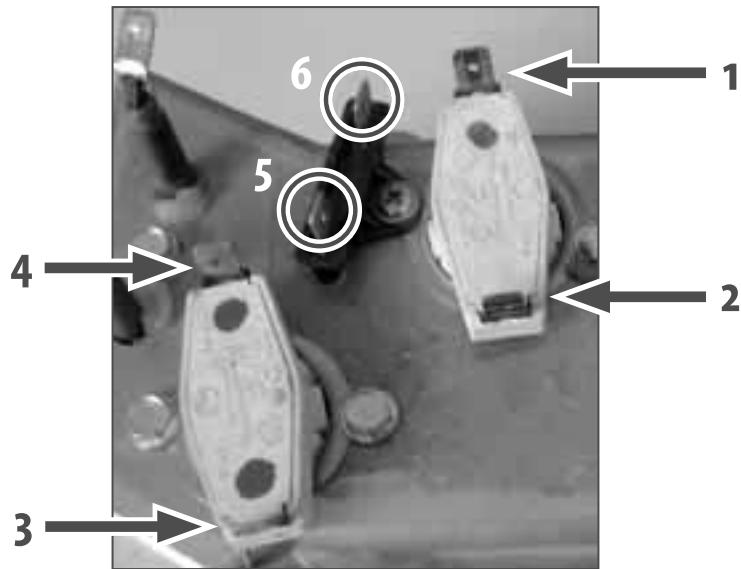

Test Points	Description	Reading
1 to 2	88 Thermostat	0 ohms
3 to 4	110 Thermostat	0 ohms
5 to 6	Fuse Link	0 ohms

7. Module Board Test

Main Motor Test Points are located on the Main Motor (See "Component Locations")



Module Board

Before performing these

tests, always check for voltage between pins 10 and 11 first. Also, verify that the wire number matches the pin number (wires will have white stencils with the corresponding pin # on them). With washer-dryer power OFF, select "10min" on Dry Time knob. Press ON/OFF button (in). Check for 120 VAC between Pins 10 and 11. If there is voltage, go to Step 2. If not, call Westland Sales.

2) Unplug washer-dryer from wall outlet. Detach connector from Pins 10 and 11. With connector still detached, plug washer-dryer back into wall outlet.

3) Select "10min" on Dry Time knob. Press ON/OFF button (in). Now, verify proper resistance between certain pins by using the chart below. If your resistance readings fall within the specified range, the Module Board is suspect. If your readings do not fall within the specified range, contact

**Westland Sales:
1-800-356-0766**

When testing is complete, unplug washer-dryer. Reattach connector to Pins 10 and 11. With connector reattached, plug washer-dryer back into wall outlet.

Pin	Function	Resistance
7 to 1	Agitate/Tumble Direction	Alternates between <5 ohms, >1000 ohms
7 to 2	High Spin	>1000 ohms
7 to 3	Medium Spin	>1000 ohms
7 to 4	Low Spin	>1000 ohms
5	Reserved	-
7 to 6	Agitate/Tumble Direction	Alternates between <5 ohms, >1000 ohms
7	Common	Ohmmeter reference connection
8 to 9	Motor - Tachometer	177 ohms +/- 20%
10 to 11	115 VAC Input - Neutral	>10,000 ohms
12 to 13	Motor - Rotor	3.0 ohms +/- 20%
14 to 15	Motor - Stator	1.2 ohms +/- 20%

8. Main Motor Test

Main Motor Test Points are located on the Main Motor (See "Component Locations"). The Main Motor has either a 7-pin or 10-Pin design. Identify which Main Motor your washer-dryer has then perform the appropriate tests.

Washer-Dryer Serial No.

9616xxxx to 9804xxxx

First, pull on wires A & B to verify they're not broken,

1. Butt splice any broken wires and secure them to the plug to prevent a future break.
2. Next, connect AC line cord to pins 5 & 3.
3. Jumper pins 4 & 2 for Normal (or pins 1 & 4 for High Speed).

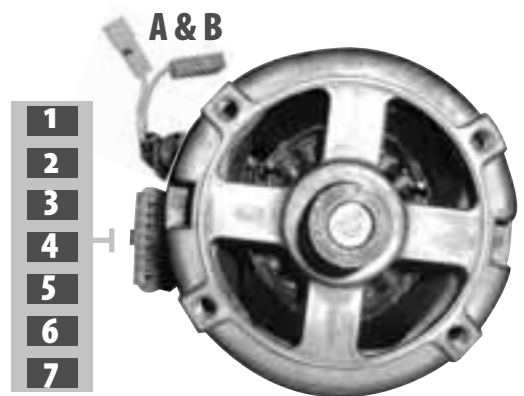

7-Pin Connector	Test Points	Reading
Motor Protector	A to B	0 ohms
Stator Tap	1 to 3	0.6 ohms
Stator	2 to 3	1.2 ohms
Rotor	4 to 5	3.0 ohms
Tachometer	6 to 7	177 ohms

Washer-Dryer Serial No.

9805xxxx and after

To test run the Main Motor

1. Connect the AC line cord to Pins 3 and 5.
2. Jumper Pin 4 to 6 (for Normal speed) or jumper pin 4 to 9 (for High speed).

NOTE: Do not run at High speed for more than 30 sec.

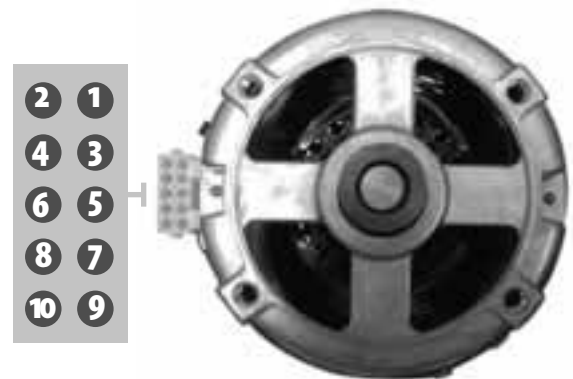

10-Pin Connector	Test Points	Reading
Tachometer	1 to 2	177 ohms
Rotor	3 to 4	3.0 ohms
Stator	5 to 6	1.2 ohms
Motor Protector	7 to 8	0 ohms
Stator Tap	5 to 9	0.6 ohms

9. Drain Pump Test

Drain Pump Test Points are located on the Water Pump (See "Component Locations").



To test the Drain Pump

Turn washer-dryer on Spin and check for voltage to ground on Pins L and N.

If there's

- voltage to Pin L but not to Pin N
- AND the pump is not obstructed

then, the pump needs to be replaced.

	Test Points	Reading
Drain Pump	L to N	4.5 ohms

10. Push Buttons, Wash Temp, Dry Time Selector Tests

ON/OFF Button and Push Button Test Points are located behind the corresponding button(s). Wash/Rinse Temp. Selector Test Points are located on the Wash Rinse Selector (See "Component Locations").

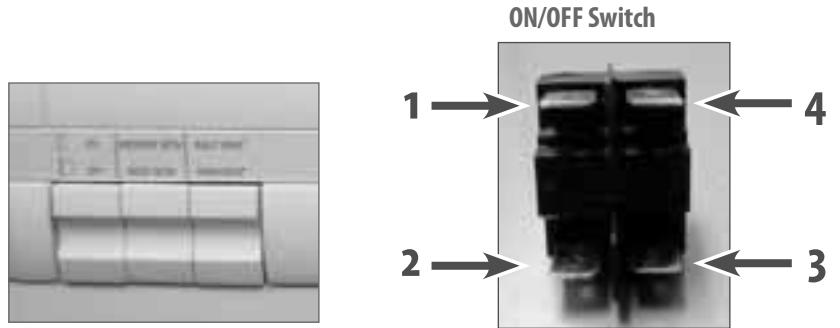

ON/OFF Button	Test Points	Reading
ON/OFF Switch (Out)	1 to 2	INFINITY (OL)
ON/OFF Switch (Out)	3 to 4	INFINITY (OL)
ON/OFF Switch (In)	1 to 2	0.0 ohms
ON/OFF Switch (In)	3 to 4	0.0 ohms

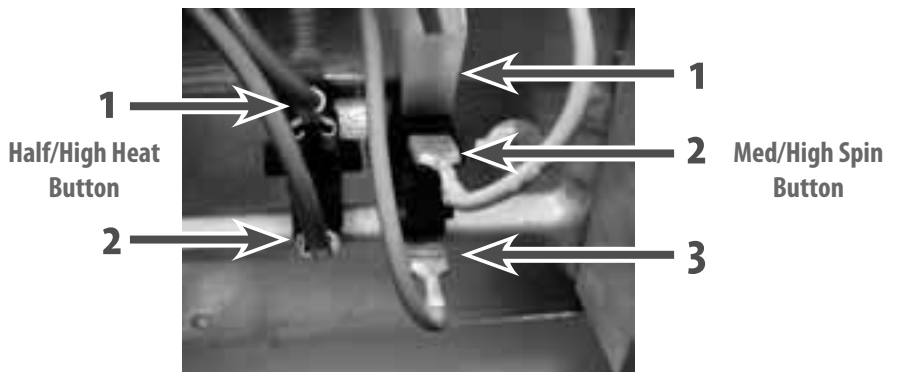

Option Buttons	Test Points	Reading
Med/High Spin (In)	2 to 3	0 ohms
Med/High Spin (Out)	1 to 3	0 ohms
High/Low Heat (In)	1 to 2	INFINITY (OL)
High/Low Heat (Out)	1 to 2	0 ohms



Wash/Rinse Temperature Selector



Wash/Rinse Temp Selector	Test Points	Reading
Hot/Warm	1 to 1a	0.2 ohms
	2 to 2a	0.2 ohms
	3 to 3a	INFINITY (OL)
Hot/Cold	1 to 1a	INFINITY (OL)
	2 to 2a	0.2 ohms
	3 to 3a	INFINITY (OL)
Warm/Warm	1 to 1a	0.2 ohms
	2 to 2a	0.2 ohms
	3 to 3a	0.2 ohms
Warm/Cold	1 to 1a	INFINITY (OL)
	2 to 2a	0.2 ohms
	3 to 3a	0.2 ohms
Cold/Cold	1 to 1a	INFINITY (OL)
	2 to 2a	INFINITY (OL)
	3 to 3a	0.2 ohms

(Continued on the next page)

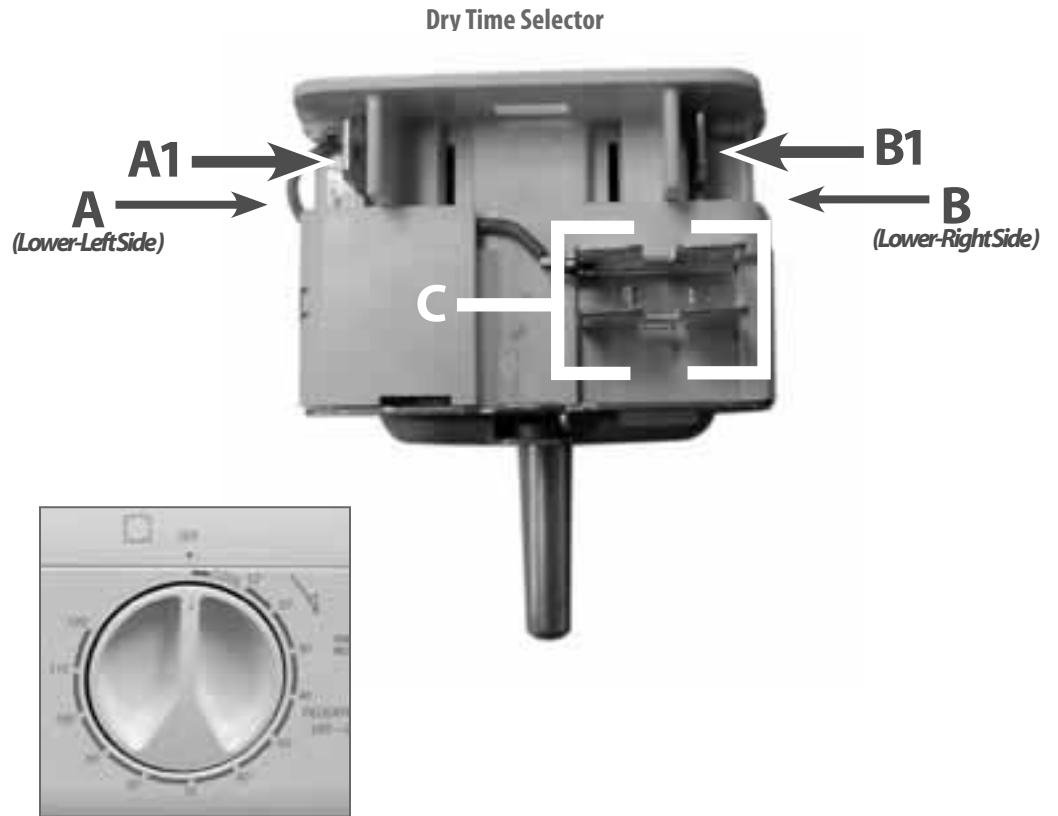

Dry Time Selector	Test Points	Reading
1-12 min.	A to A1	0.2 ohms
	B to B1	INFINITY (OL)
	C to A1	2.1 K
13-120 min.	A to A1	0.2 ohms
	B to B1	0.2 ohms
	C to A1	2.1 K

11. Wash Timer

The Wash Timer Test Points are located on Wash Timer (See Component Locations”). The following is an explanation of how to use the two Step Charts found in this section.

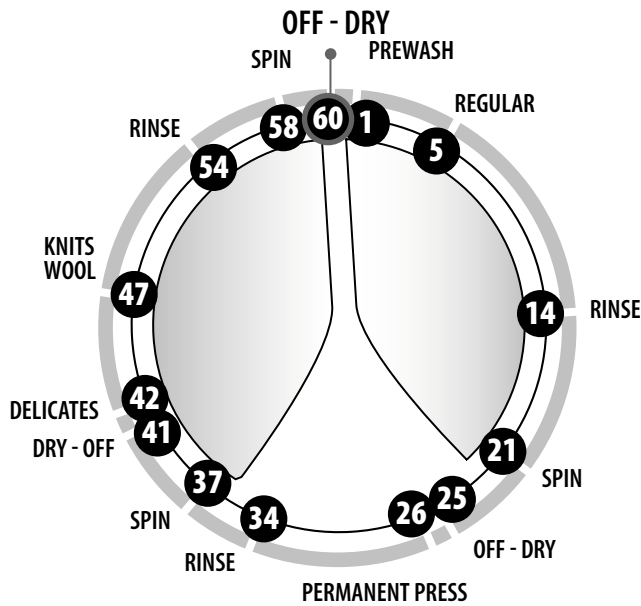

Reading the Step Chart

The Step Chart on the following pages, provide all the information you need to verify if the Wash Timer is working correctly for a given function.

- The top rows list all of the **60 positions** on the Wash Cycle knob (See the Illustration on the Left).
- The first three columns list the **Row (A-F)** and **Number (1-12)** of Pins on the Wash Timer (Below).

When and How to Perform Wash Timer Tests

For example, if the unit wasn't working in the High Spin cycle, but the Module Board and Main Motor tested correctly. You would then verify that the Wash Timer is working correctly.

Find out when the machine is going into a High Spin:

- Locate "High Spin" in the **Function** column (Pin B4 to Pin B5)
- Follow the "High Spin" Row to a **dot** (Position 24)

Then, to perform the above test, you would:

1. Turn the Wash Timer knob to position **24 ("Drain, High Spin")**
2. Use an ohm meter to verify that **Pin B4** has continuity to **Pin B5**.
3. If there is continuity, the Wash Timer is working correctly. If there is no continuity, the Wash Timer needs to be replaced.

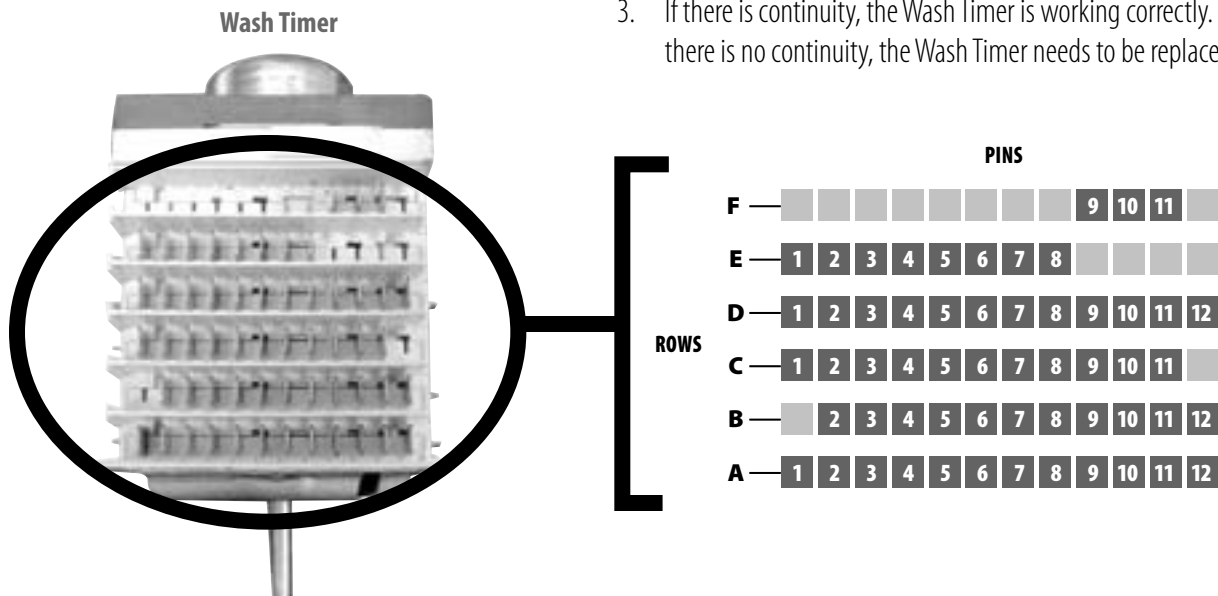

Problem / Testing Procedure Chart

Follow these steps in the order they are listed to effectively troubleshoot the problem.
Call Westland Sales if the problem continues after you have completed the recommended tests.

Problem	Testing Procedure
WON'T POWER UP	<ol style="list-style-type: none"> 1. Check the line voltage for blown fuses. 2. Check for voltage going to the washer-dryer. 3. Before continuing, unplug the unit. 4. Check continuity of line cord and line filter. 5. Check the Door Switch (see "Accessing the Components" pg. 30 and "Component Testing" pg. 40)
WON'T START CYCLE	<ol style="list-style-type: none"> 1. Verify that the door is closed. 2. Verify there is water entering the Hot and Cold Valves. 3. Check the Door Switch (see "Accessing the Components" pg. 30 and "Component Testing" pg. 40) 4. Remove the washer-dryer top and check the wire harness connections from the power cord (see "Accessing the Components" pg. 27)
WON'T COMPLETE CYCLE	<ol style="list-style-type: none"> 1. Check COLD water to inlet valve. 2. Check for kinked COLD water hose.
WON'T DISPENSE LAUNDRY AIDS	<ol style="list-style-type: none"> 1. Verify the unit is level (see "Level the Washer-Dryer" pg. 10) 2. Verify the Dispenser Drawer is not clogged with detergent. 3. Check water connections to the unit. Check for plugged water valve screen. 4. Remove the top and check water connections within the unit. 5. Check the Wash Timer (see "Accessing the Components" pg. 28 "Component Testing" pg. 52)
WON'T FILL	<ol style="list-style-type: none"> 1. Check installation. 2. Check inlet valves. Verify there is water entering the Hot and Cold Valves. 3. Check water connections to the unit. Check for plugged water valve screen. 4. Remove the top and check water connections within the unit. 5. Check the Door Switch (see "Accessing the Components" pg. 30 and "Component Testing" pg. 40)
OVERFILLS	<ol style="list-style-type: none"> 1. Verify the unit is level (see "Level the Washer-Dryer" pg. 10) 2. Check Pump Drain system - this could indicate a failure to drain (see "Installation Information" pg. 9-10, "Accessing the Components" pg. 35 and "Component Testing" pg. 48). 3. Check the Pressure Switch (see "Accessing the Components" pg. 32 and "Component Testing" pg. 42) 4. Check Pressure Switch hose for holes, cut marks, etc.
DRUM ROTATES DURING SPIN AND DRY CYCLES, BUT NOT DURING WASH	<ol style="list-style-type: none"> 1. See "Replacing the Wire Connectors on the Pressure Switch" pg. 58 2. Check the Pressure Switch (see "Accessing the Components" pg. 32 and "Component Testing" pg. 42)

Problem	Possible Cause / Recommended Testing
DRUM WON'T ROTATE	<ol style="list-style-type: none"> 1. Remove the washer-dryer back and check the Drive Belt (See "Accessing the Components" pg. 37) 2. Check the Module Board (see "Accessing the Components" pg. 38 and "Component Testing" pg. 46) 3. Test the Main Motor (see "Accessing the Components" pg. 37 and "Component Testing" pg. 47)
WON'T DRAIN	<ol style="list-style-type: none"> 1. Remove the washer-dryer back and check the Drain Pump (see "Accessing the Components" pg. 35 and "Component Testing" pg. 48) 2. Check that the Lint Filter is clear of foreign objects (see "To Clean Out the Filter" pg. 36) 2. Check that the Drain Hose is clear of foreign objects (see "Accessing the Components" pg. 27)
MACHINE VIBRATES	<ol style="list-style-type: none"> 1. Verify the Transit Bolts/Spacers have been removed (see "Remove the Transit Bolts/Spacers" pg. 9) 2. Check the Installation (see "Location" pg. 5) 3. Check the Leveling Feet (see "Level the Washer-Dryer" pg. 10) 4. Check for a weak floor. DO NOT install on carpet. <p>NOTE: Some vibration is normal.</p>
INCORRECT WATER TEMPERATURE	<ol style="list-style-type: none"> 1. Check that the Inlet Hoses are connected properly (see "Connect the Inlet Hoses" pg. 9) 2. Remove the washer-dryer top and check the wiring to the Water Temperature Selector and the Wash Timer (see "Accessing the Components" pg. 27)
WON'T DRY	<ol style="list-style-type: none"> 1. Check controls (see "How to Set a Dry Cycle ONLY" pg. 22) 2. Verify that the drum is not overloaded. Dryer load size should not exceed 6-8 pounds. 2. Perform a "Dryer Airflow and Heat Test" (see pg. 57)

Performing a Dryer Airflow & Heat Test

To perform this test, you will need a flat-head screwdriver.

1. Open the door.
2. Set the Cycle Selector knob to any OFF-DRY cycle.
3. Set the Dry Time knob to '30' minutes.
4. Push the 'ON/OFF' button IN.
5. Activate the Door Switch by inserting a screwdriver tip about 1/4" into the door hook entry hole. Using the screwdriver, move the black-colored slide mechanism to the right until it stops. HOLD the mechanism in place until the dryer turns on. (Approx. 10 seconds)
6. Place your hand on the Porthole Diaphragm at the 1 o'clock position to feel for heat and airflow. The airflow should be similar to a hand-held hair dryer on LOW and it should start heating up within 20 seconds. IF THERE IS LITTLE TO NO HEAT OR AIRFLOW, refer to the Fan Motor Test, Heater Coil Test and Fuse Links & T-Stats Tests (see Component Testing, pages 43-45).
7. Release the Door Switch by closing the door. It should spring back to the Left.

If you test a model WD802 or WD802M and the AIRFLOW AND HEAT TEST RESULTS ARE NORMAL BUT THE PROBLEM PERSISTS, check the dryer exhaust system for obstructions:

- With the dryer ON and the door closed, check the airflow exiting from the vent located on the outside wall and clear any obstructions.
- Disconnect the flex/metal dryer ducting from the back of the machine. With the dryer ON, check the airflow exiting from the back of the machine and clear any obstructions.

If you test a ventless model WDC1024(M) WDC1025(MCEE) and the AIRFLOW IS WEAK BUT THE AIR IS STILL BEING HEATED:

- Follow the instructions for "Performing Air Duct Maintenance" (see Tech Tips, page 60)



Performing a Pump Failure Test

To perform this test, you will need a wooden dowel, or another non-conductive tool that is approximately 1/2" wide x 24" long.

1. Open the Filter Door by pressing on the left side (see left). You will notice a small gap between the drain filter door and the case of the unit. Shine a flashlight through this opening and **locate the white cooling fins** toward the back of the washer.
2. Advance the Program Selector knob to a SPIN.
3. Press the ON/OFF button (IN).
4. Using the wooden dowel, rotate the cooling fins by pushing the bottom of the fins away from you. This should free up the pump.
 - If the cooling fins spin freely but the unit does not pump out water, you will have to perform the **'Water Pump Test'** in the Component Testing section of this manual.
 - If the pump is seized, it may have an obstruction. Check for an obstruction by removing the Drain Pump (see "Component Access") and removing the 3 or 4 brass-colored screws that secure the white housing to the pump. Remove any obstructions.

Replacing Wire Connections on the Pressure Switch

To perform this test, you will need a 7mm screw driver, a box knife, a wire crimper, up to 3 new wire connectors.

1. Four 7mm screws secure the main top at the back of the washer-dryer. Remove these screws and lift straight up on the rear of the main top, then slide it forward to remove it.
2. Remove the white plug that is connected to the Pressure Switch (see right). Inspect the bottom of the plug for any evidence of heat build-up that could indicate a high resistance connection. If the double-red, black, or double-white wires show any signs of heat, they will need to be removed by cutting them out of the plug and adding new connectors to each of the effected wires.
3. Mark the wires for easy re-installation.
4. Unplug each affected wire. For each wire, remove the damaged end and crimp on a new connector.
5. Using a box knife, remove the now blank area of the white plastic plug (see right).
6. Re-connect the intact side of the plug back into the Pressure Switch (see below).

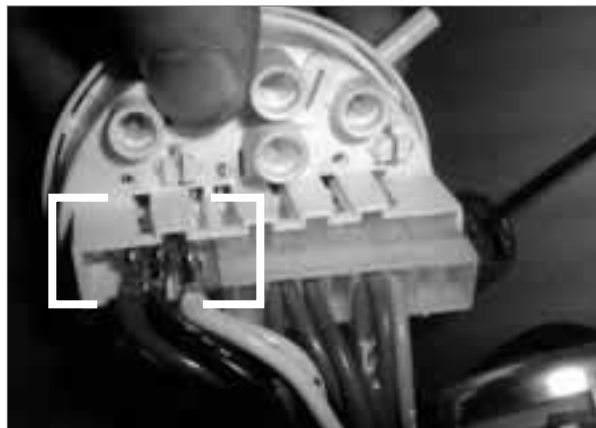

7. Connect the wires with the new connectors directly into the corresponding terminals on the Pressure Switch (see left).
8. Test unit for proper operation (see "Verifying Normal Operation"). Reinstall washer top. *Done.*

Modifying Hoses to Improve Condenser Drying Performance (WDC1024M and WDC1025MCEE models ONLY)
To perform this modification, you will need a 7mm screw driver.

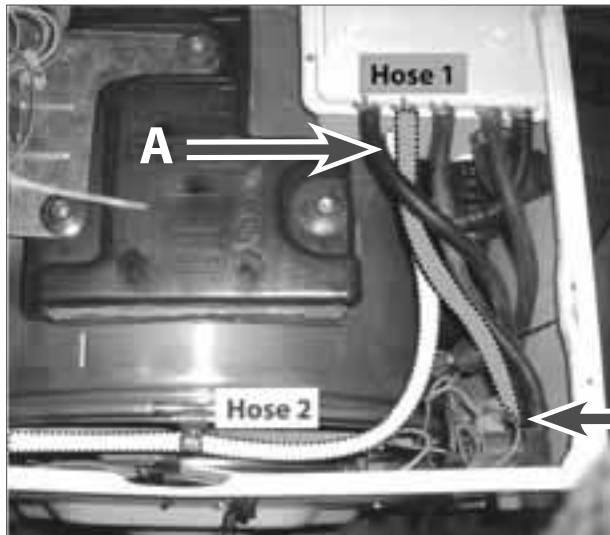

1. Four 7mm screws secure the main top at the back of the washer-dryer. Remove these screws and lift straight up on the rear of the main top to remove it.

2. **Detach** hose 1 from point B (see left)

3. **Detach** hose 2 from point A (see left)

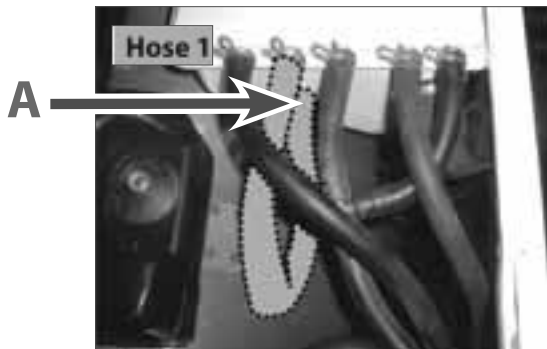

4. **Attach** hose 1 to point A (see left).

NOTE: This hose may become kinked. This is normal.

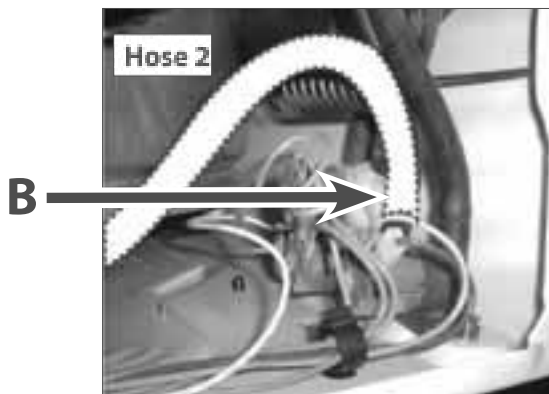

5. **Attach** hose 2 to point B (see left).

NOTE: This hose CANNOT be kinked. If needed, twist the hose to make it more rigid.

6. Test unit for proper operation (see "Verifying Normal Operation").
Reinstall washer top. *Done.*



Part No. 100A

Performing Condenser Air Duct Maintenance (WDC1024M and WDC1025MCEE models ONLY)

To perform this test, you will need a 7mm screwdriver, a drill with a 4" wire wheel, a portable vacuum and Condenser Cleaning Kit (Part No. 100A) or similar. Kit 100A is available from Westland Sales and contains: 1 impeller assembly, 3 gaskets, and 1 flexible brush.

Air Duct's in Condenser Dryers will need routine maintenance to keep airflow at maximum velocity. Fabric Softener or continual oversudsing will build up inside the machine and restrict airflow. The water return port may also become plugged solid. Cleaning intervals of one year or more are normal.

1. Remove the four 7mm screws that secure the washer top and lift straight up on the rear of the top to remove it. With the machine power OFF, remove the air duct mounting bracket from air duct and counter weight. Lift heater duct straight off of seal at rear and pivot whole assembly toward center of machine. Leave the heater duct attached to porthole diaphragm at front (see right).



2. Inspect the Fan. Fins can be bull-nosed shut with lint. Clean them out with compressed air or remove the fan and replace it with a new one.



3. Note the air passageway stamped into the outer drum and the rubber seal in place. Remove and clean (or replace) this seal. **Note the two gaskets on the heater housing assembly (see above-right). When reinstalling the assembly, you must align these two gaskets with the corresponding holes.**

4. Remove fan motor and attached impeller. Clean and inspect heater duct. Using a drill with a 4" wire wheel brush, clean the heater duct thoroughly (see right). A portable vacuum could be handy here as well.

- Make sure the water return port on inside edge is clear so water may travel back into the drum. If the weep hole is not clear and goes unchecked, the unit will not dry properly.





5. This is the heater duct with fan motor and impeller removed (see left). It should look somewhat like this when cleaned and is ready to be reassembled. Clean or replace gasket located on the top edge between fan motor and heater duct.

6. Remove any debris from contour duct in outer drum using a 2" soft bristle brush with water (see right). Be careful not to dislodge water inlet. A portable vacuum cleaner is handy here as well.

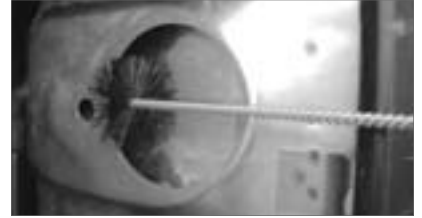

- When clean, flush with water to clear any obstruction and restore max. air flow.



7. To remove fan Impeller, first remove brass nut (see left). Turn retaining nut clockwise (left hand threads). To remove impeller pull straight off the motor shaft. Clean or replace impeller.



8. Reassemble heater duct to drum. Be sure housing is sealed to drum via cleaned, or new rubber gaskets.

After carefully aligning the gaskets with the holes, apply downward pressure (see right) as you

tighten the two nuts that secure the heater housing bracket to the counterweight. If the gaskets are not seated correctly, the unit will leak.

- Next, run machine through a RINSE cycle to flush any remaining particles into the wash filter. Clean the filter (See "To Clean Out the filter" below). *Done!*



To Clean Out The Filter

First, place a towel beneath the filter area to catch any water that may come out. With the machine empty and OFF, turn the Program Selector Knob to the start of the first spin cycle (see right). Next, Push the power button ON (In). The drum will begin spinning. *NOTE: You'll have 5 minutes to complete this task before the pump begins cycling.*



Open the Filter Door by pressing on the left side (see above-left).

Turn the filter counter-clockwise to release it from its housing. Pull it out. *NOTE: If you have difficulty, the rubber handle ends of pliers or a similar tool can be used to unscrew or tighten the filter (see below).*

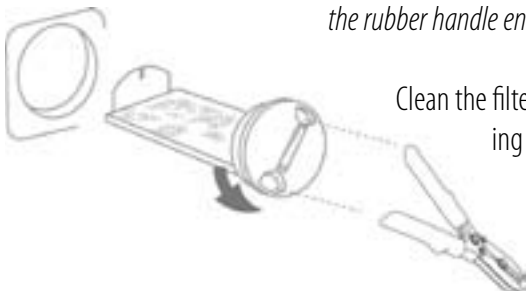

Clean the filter under running water to help remove all lint and debris. Replace the filter by sliding it back into its housing and turning clockwise to tighten securely. Finally, close the Filter Door and press the Power button OFF (Out).

Winterization Instructions (Recreational Vehicle and Marine Installations)

To winterize your washer-dryer:

1. With the machine power OFF, pour ½ quart of RV-type antifreeze into the washer drum
2. Close the door. Advance the Program Selector knob to a SPIN position
3. Press ON/OFF Button (IN). Wait 1-2 minutes
4. Press ON/OFF Button (OUT). Unplug the washer-dryer from the electrical outlet (or disconnect power)
5. Turn the water supply faucets OFF. Disconnect the inlet hoses from the faucets. Drain any remaining water from the hoses. *Finished!*

Optional RV Winterization - If you're currently pumping antifreeze through the fresh water system, follow these steps to winterize:

1. With the machine power OFF, turn the WASH TEMP knob to WARM/WARM
2. Advance the Program Selector knob to REGULAR WASH (Not PreWash)
3. Press the ON/OFF button (IN) and let the machine fill until antifreeze is in the drum
4. Advance Program Selector to a SPIN position. Press ON/OFF Button (IN). Wait 1-2 minutes
5. Press the ON/OFF button (OUT). *Finished!*

To use again, flush the water pipes, then:

1. Reconnect the water inlet hoses to the corresponding HOT/COLD faucets. Turn the faucets ON. (NOTE: Check the water inlet hoses and pump periodically. Refer to the "Use & Care Guide" that came with the machine)
2. Plug the washer-dryer into an appropriate electrical outlet (or reconnect power supply)
3. With the ON/OFF button in the off (OUT) position, pour 1/2 TBSP. of powder detergent (or liquid equiv.) into the 'Detergent' compartment inside the Dispenser Drawer
1. Turn the WASH TEMP knob to WARM/WARM
4. Advance the Program Selector knob to REGULAR WASH
5. Press the ON/OFF button (IN) and allow the machine to run through the complete cycle to clean out any remaining antifreeze. *Finished!*

NOTES:

Verifying Normal Operation

Follow these steps in the order they are listed to test the washer-dryer for normal operation.

We recommend that you ALWAYS perform this test as the last step of your repair. It takes approximately 8 min. to complete.

Introduction

The following instructions explain how to test the washer-dryer to make sure everything's working properly. Keep in mind, this

appliance operates differently than some of the previous Splendide models you may be familiar with.

Before beginning this test, remove all items from the drum and close the door.

You Select	Correct Washer-Dryer Response	Components Checked
1. 'Regular' on Cycle knob AND 'Warm/Warm' on Temp knob THEN 'ON/OFF' button (in)	<ul style="list-style-type: none"> Hot water will enter dispenser compartment "B" and Cold water will enter compartment "A". Open the Dispenser Drawer to verify. When the unit is finished filling, the drum will rotate in one direction, pause and then rotate in the opposite direction. 	Water Valves Pressure Switch Main Motor Module Board
2. 'ON/OFF' button (out)	<ul style="list-style-type: none"> Washer-dryer will power off. 	ON/OFF Switch
3. Any 'Spin' on Cycle knob THEN 'ON/OFF' button (in)	<ul style="list-style-type: none"> Water will drain from drum. Drum will ramp up into Spin. 	Water Pump
4. 'ON/OFF' button (out)	<ul style="list-style-type: none"> Washer-dryer will power off. 	
5. Any 'OFF-Dry' on Cycle knob AND '20'' on Dry Time knob THEN 'ON/OFF' button (in)	<ul style="list-style-type: none"> Fan motor will start running. Drum will rotate in one direction, pause and then rotate in the opposite direction. Let it appliance run for approx. 2 min. until the door unlocks. Finally, open the door and verify that there is heat in the drum. 	Fan Motor Heating Element
4. 'ON/OFF' button (out)	<ul style="list-style-type: none"> Washer-dryer will power off. 	

-- End --

NOTES:

Wiring Diagrams

WD802M
WDC1024M*
WDC1025M*

SERIAL NUMBERS THAT BEGIN WITH
9616 to 9719

DIAGRAM LEGEND	
AT	Dry Timer Motor
BM	Surge Suppressor
BP	Door Switch
FU	Dryer Safety Fuse
EF	Cold Water Electrovalve
EC	Hot Water Electrovalve
EF/A	Cold Water Softener Electrovalve
EF/AS	Cold Water Condenser Electrovalve
IA	On/Off Push Button
IF	High/Medium Spin Switch
IP	High/Half Heat Switch
MC	Main Motor
R	Rotor Windings
S	Stator Windings
D	Tachometer
ME	Module Control Board
MT	Wash Timer Motor
MV	Fan Motor
PM	Motor Heat Protector
PR	Pressure Switch
LS	Security Level
LN	Normal Level
LO	High Level/Overflow Protection
PS	Discharge Pump
RA	Heating Element
SM	Water Temperature Selector

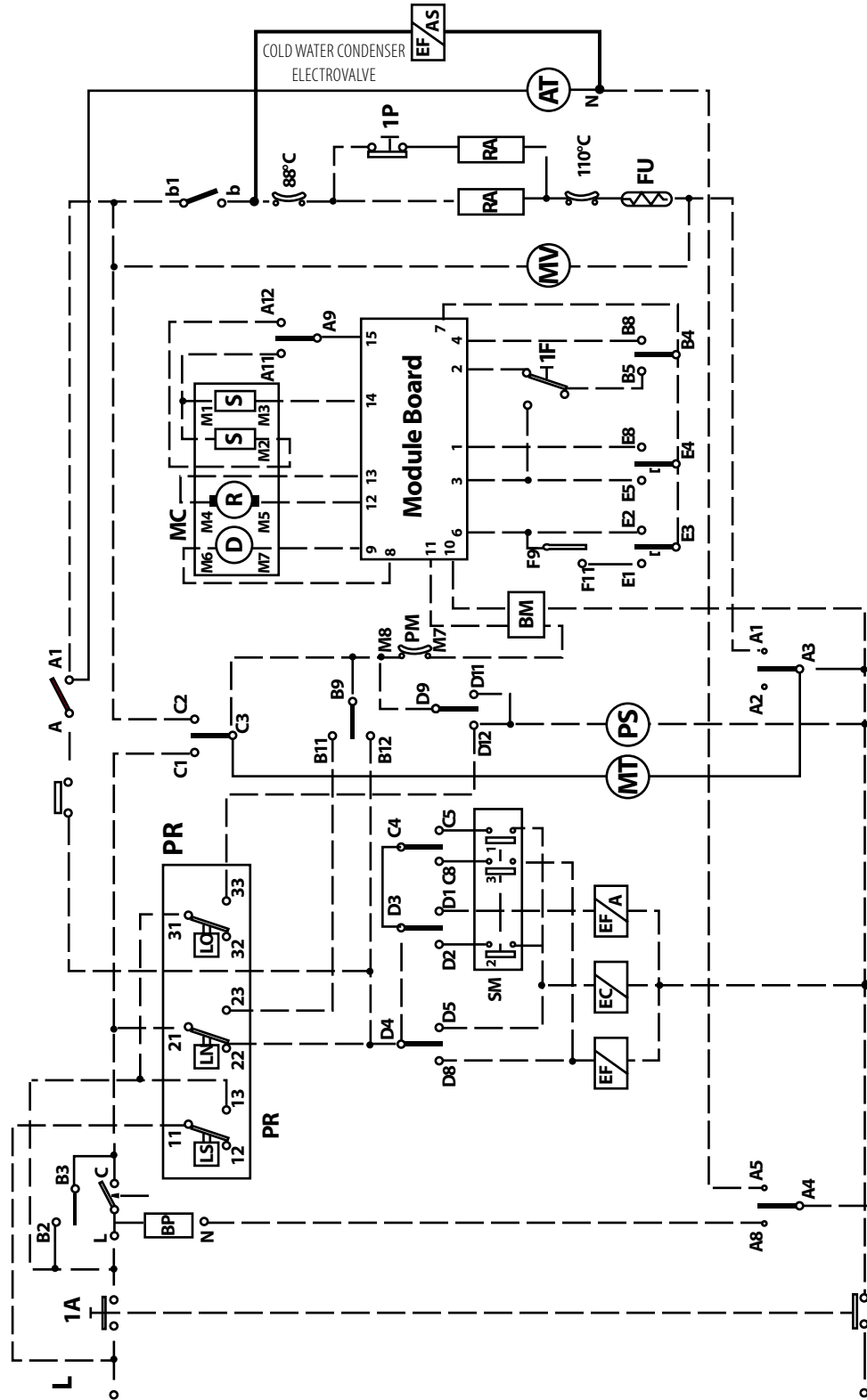

* MODELS DENOTED WITH AN ASTERISK HAVE A COLD WATER CONDENSER ELECTROVALVE

WD802M
WDC1024M*

SERIAL NUMBERS THAT BEGIN WITH
9720 to 2050

WDC1025M*

SERIAL NUMBERS THAT BEGIN WITH
9720 to 9943

DIAGRAM LEGEND	
AT	Dry Timer Motor
BM	Surge Suppressor
BP	Door Switch
FU	Dryer Safety Fuse
EF	Cold Water Electrovalve
EC	Hot Water Electrovalve
EF/A	Cold Water Softener Electrovalve
EF/AS	Cold Water Condenser Electrovalve
IA	On/Off Push Button
IF	High/Medium Spin Switch
IP	High/Half Heat Switch
MC	Main Motor
R	Rotor Windings
S	Stator Windings
D	Tachometer
ME	Module Control Board
MT	Wash Timer Motor
MV	Fan Motor
PM	Motor Heat Protector
PR	Pressure Switch
LS	Security Level
LN	Normal Level
LO	High Level/Overflow Protection
PS	Discharge Pump
RA	Heating Element
SM	Water Temperature Selector

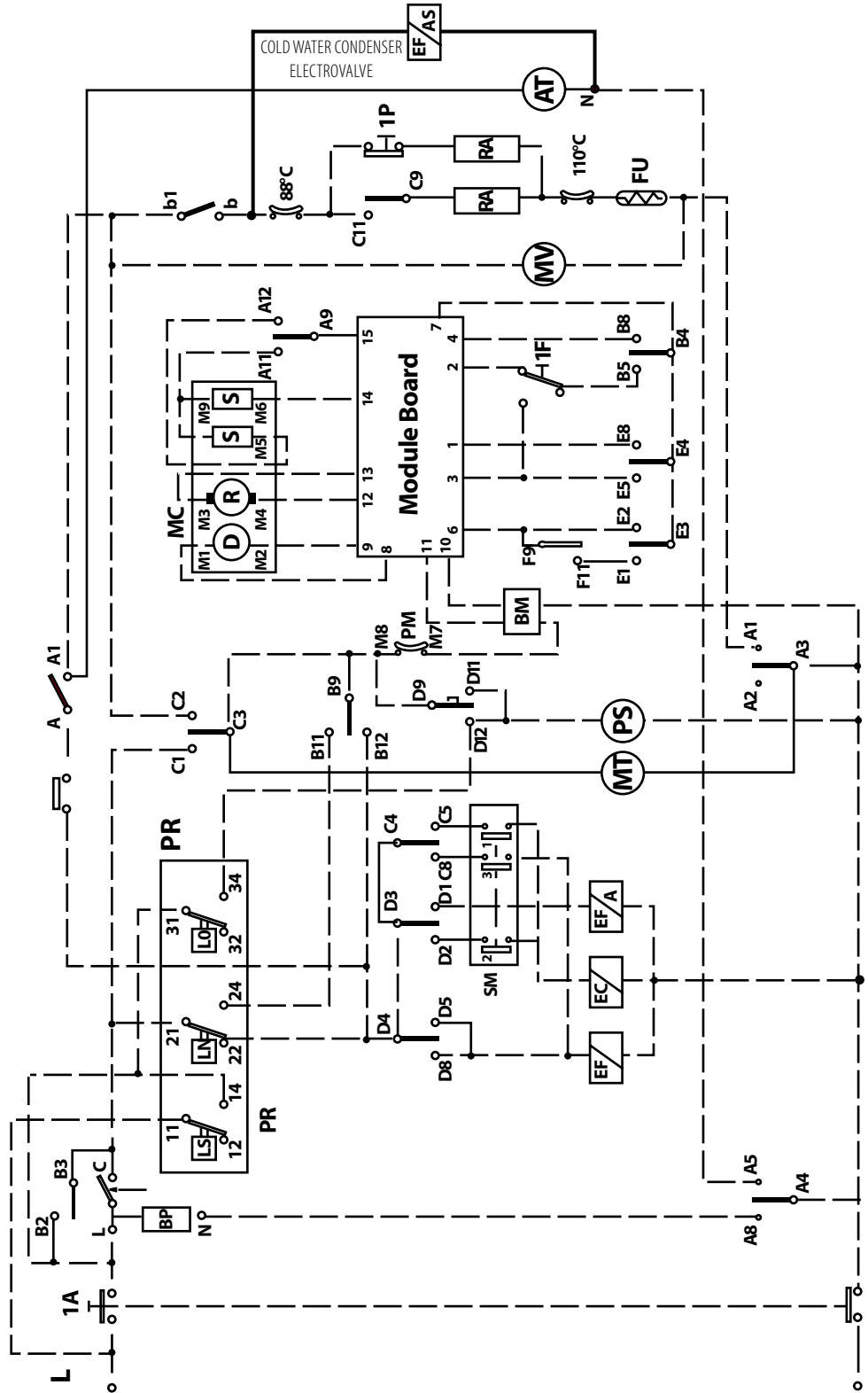

* MODELS DENOTED WITH AN ASTERISK HAVE A COLD WATER CONDENSER ELECTROVALVE

WDC1025MCEE

SERIAL NUMBERS THAT BEGIN WITH
9943 to 2050

DIAGRAM LEGEND	
AT	Dry Timer Motor
BM	Surge Suppressor
BP	Door Switch
FU	Dryer Safety Fuse
EF	Cold Water Electrovalve
EC	Hot Water Electrovalve
EF/A	Cold Water Softener Electrovalve
EF/AS	Cold Water Condenser Electrovalve
IA	On/Off Push Button
IC	Water Level Switch
IF	High/Medium Spin Switch
IP	High/Half Heat Switch
MC	Main Motor
R	Rotor Windings
S	Stator Windings
D	Tachometer
ME	Module Control Board
MT	Wash Timer Motor
MV	Fan Motor
PM	Motor Heat Protector
PR	Pressure Switch
LS	Security Level
LN	Normal Level
LO	High Level/Overflow Protection
PS	Discharge Pump
RA	Heating Element
SM	Water Temperature Selector

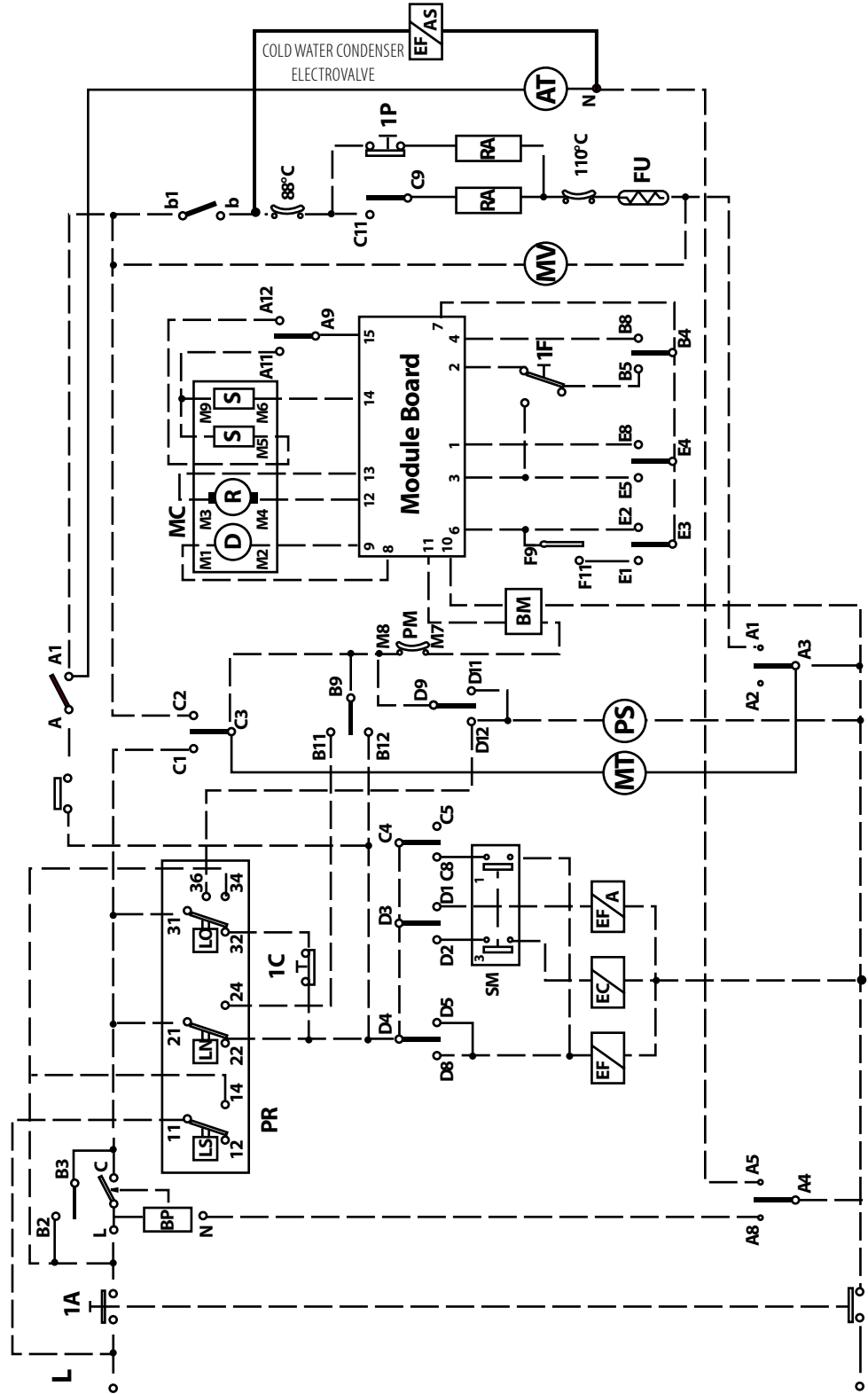

* THIS MODEL HAS A COLD WATER CONDENSER ELECTROVALVE

NOTES:



Splendide®

© Copyright 2006, Westland Sales, Clackamas, OR 97015