

 **Hotpoint**  
ARISTON

## WASHING MACHINES

<b>Models Covered</b>	<b>Comm. Code</b>
---------------------------	-----------------------

<b>LED</b>	
<b>ARXXL105EU</b>	<b>47553</b>
<b>ARXXL105IT</b>	<b>51215</b>

<b>DIGIT</b>	
<b>ARXXF125EU</b>	<b>49055</b>

# *Service Information*

## SAFETY NOTES & GENERAL SERVICING ADVICE

---

1. This manual is NOT intended as a comprehensive repair/maintenance guide to the appliance.
2. It should ONLY be used by suitably qualified persons having technical competence applicable product knowledge and suitable tools and test equipment.
3. Servicing of electrical appliances must be undertaken with the appliance disconnected (unplugged) from the electrical supply.
4. Servicing must be preceded by Earth Continuity and Insulation Resistance checks.
5. Personal safety precautions must be taken to protect against accidents caused by sharp edges on metal and plastic parts.
6. After servicing the appliance must be rechecked for Electrical Safety. In the case of appliances which are connected to a water supply (i.e.: Washing Machines, Dishwashers & Food Centres etc.) checks must be made for leaks from seals gaskets and pipe work and rectification carried out where necessary.
7. It can be dangerous to attempt 'DIY' repairs / maintenance on complex equipment and the Company recommends that any problem with the appliance is referred to its own Service Organisation.
8. Whilst the Company has endeavoured to ensure the accuracy of the data within this publication they cannot hold themselves responsible for any inconvenience or loss occasioned by any error within.

## SERIAL NUMBER / INDUSTRIAL CODE EXPLANATION

---

### Serial Number Example

3 10 02 0895

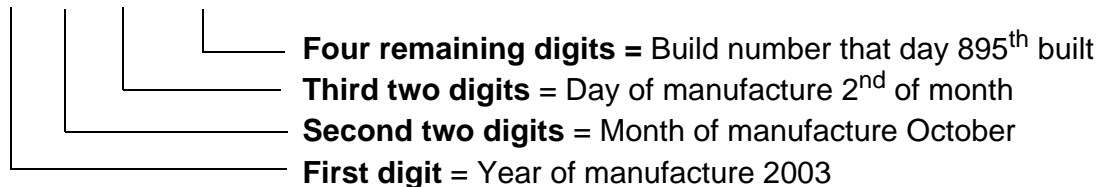

### Industrial Code Example

37 24455 0010

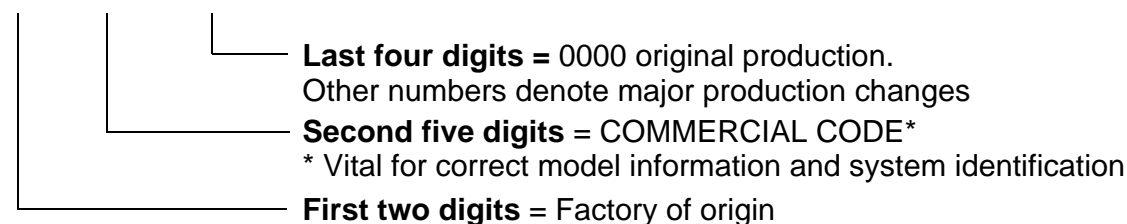

**INDEX**

---

<b>Safety &amp; Servicing Notes</b> .....	<b>2</b>
<b>Manufacturing Serial Number Information</b> .....	<b>2</b>
<b>Development History</b> .....	<b>3</b>
<b>Specifications</b> .....	<b>4</b>
<b>Controls</b> .....	<b>5 - 6</b>
<b>Options</b> .....	<b>7</b>
<b>Demo Mode - ARXXF125EU</b> .....	<b>8</b>
<b>Controls Information</b> .....	<b>9</b>
<b>Option Availability</b> .....	<b>10</b>
<b>Wiring Diagrams</b>	
<b>LED</b> .....	<b>11</b>
<b>Digit</b> .....	<b>12</b>
<b>Wiring Connection Chart</b> .....	<b>13</b>
<b>Wiring Diagram Legend</b> .....	<b>14</b>
<b>Power Module Connections</b> .....	<b>15</b>
<b>Error Codes &amp; Possible Causes</b> .....	<b>16</b>
<b>Dismantling Instructions</b> .....	<b>17 - 26</b>

## SPECIFICATIONS

---

<b>Models Covered</b>	LED Display models - ARXXL105EU, ARXXL105IT DIGIT Display - ARXXF125EU		
<b>Colour</b>	White		
<b>Dimensions</b>	Height 850 mm	Width 595 mm	
	Depth 580 mm	Weight 72 kg	Packed approx. 73.5 kg
<b>Country of Origin</b>	Great Britain		
<b>Electrical Supply</b>	220 - 240 Volt AC @ 50 Hz Fuse 13 amp		
<b>Energy</b>	Energy Class: A+ @ 6 kg		
<b>Washing Performance</b>	Class: A+ Spin Efficiency Class: B		
<b>Energy Consumption</b>	1.02 kWh / Cycle @ 60°C Cotton		
<b>Water Consumption</b>	55 Litres @ 60°C Cotton		
<b>Wash Load</b>	6.0 kg Cottons		
<b>Washing &amp; Drying Load</b>	5.0 kg Cottons		
<b>Spin Speed</b>	ARXXL105EU - 1000 rpm ARXXL105IT - 1000 rpm ARXXF125EU - 1200 rpm		
<b>Control PCB</b>	220/240 Volt 50/60 Hz Type Merloni EVO 2		
<b>Water Supply</b>	Cold Valve - Coil Resistance 3.8 K $\Omega$ Max Pressure = 1 Mpa (10bar) Minimum Pressure = 0.05 Mpa (0.5bar)		
<b>Wash Heater</b>	1800 Watts @ 230 volts	Resistance	30 $\Omega$ approx.
<b>Thermistor NTC</b>	Resistance: 20 K $\Omega$ @ 20°C		
<b>Pump</b>	2 Pole Synchronous 220 / 240 Volt 25 Watt, Resistance = 162 $\Omega$		
<b>Door Lock</b>	P.T.C. Solenoid with emergency door release		
<b>Torque Settings</b>	Upper Balance Weight = 24 Nm Lower Balance Weight = 24 Nm		

- Make sure that you allow enough space for the machine. Select a space at least 60 cm wide, 60 cm deep and 85 cm high. Also leave enough space to open the door fully, so that you can load and unload it easily.
- Where possible, the machine should be positioned on a solid floor to minimise vibration.
- Take care when you move the machine not to rip any floor coverings.

### Levelling

The machine will be noisy if the two front feet are not adjusted so that the machine stands firm and level.

- The machine should be levelled from side to side and from front to back.

## CONTROLS

### LED MODEL

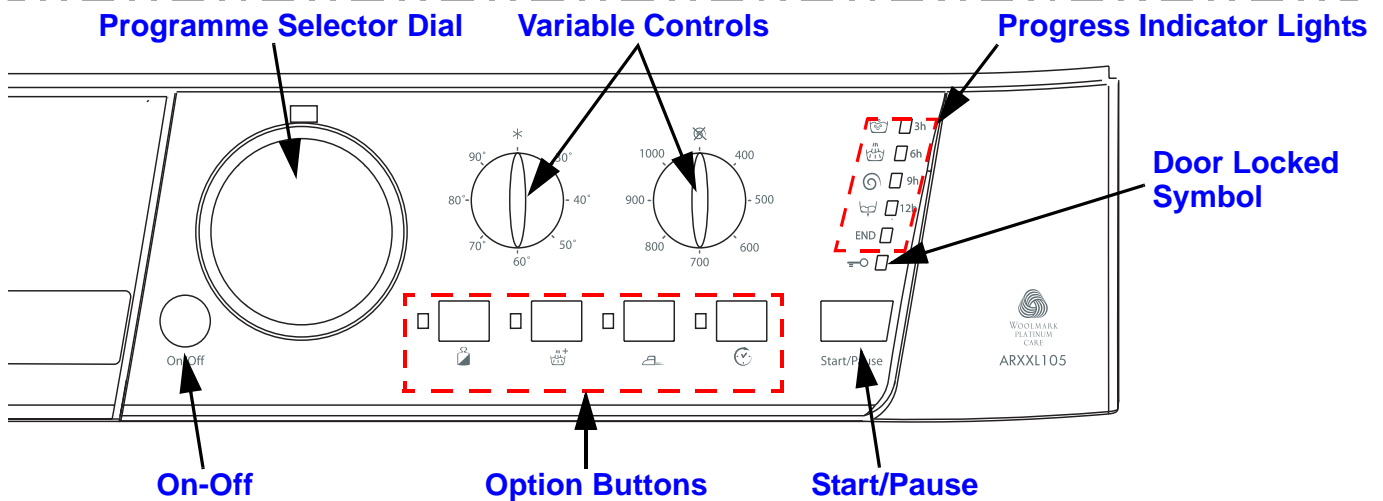

### DIGIT MODEL

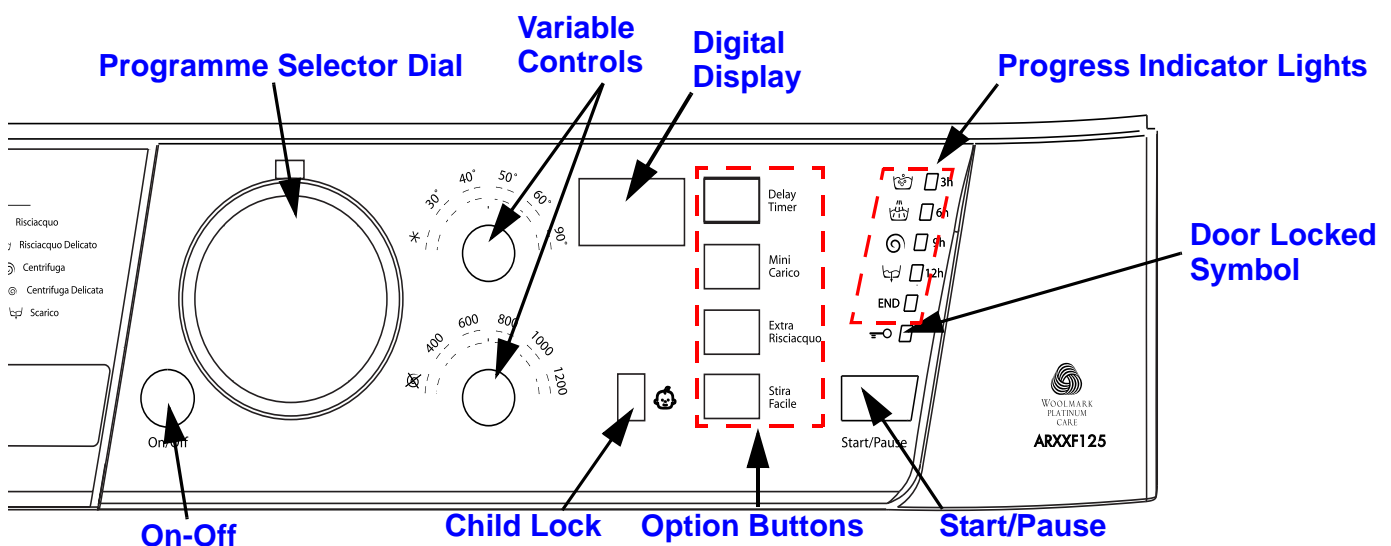

### ON-OFF / SELECTING A PROGRAMME

The machine is switched on by pressing the ON-OFF button.

All the indicator lights will light up for a few seconds.

Turn the programme selector dial to the desired programme.

Load the laundry and detergent.

Select the Option you require, a time will be indicated in the display window.

Press the Start / Cancel button.

A beep will be heard followed by a CLUNK from the door lock Solenoid as it locks the door, at this stage the door locked indicator symbol will light.

### TO STOP OR CHANGE A PROGRAMME

Press the ON-OFF button for approximately 3 seconds

Select PUMP OUT on the programme dial.

Switch on and re-start

When the machine has finished emptying.

Press the ON-OFF button

Select a new programme and re-start

**NOTE:** If you cancel a HOT wash or Dry programme, take care when removing the laundry, it may still be VERY HOT.

### PROGRESS INDICATOR LIGHTS

These lights will light up when you choose a programme, to indicate the progress of the selected programme.

When started, the first light in the cycle will stay lit and as the programme progresses, successive lights will come on until the programme finishes.

### DOOR LOCKED INDICATOR LIGHT

The 'Door Locked' indicator light will come on when you press the START / PAUSE button and will stay lit throughout the programme. When the programme has finished the indicator light will go out and you can then open the door, a double CLUNK noise will be heard from the door lock Solenoid at this point.

If the door is not closed properly prior to starting a programme the door lock solenoid will 'CLUNK' approximately 5 times followed by a flashing DOOR indication in the display window, every 5 seconds from then onwards there will be an audible beep.

Push the door closed and press START / PAUSE button to commence the cycle.

### CHILD LOCK - Model ARXXF125

To set the Child Lock, start the programme required then press and hold the Child Lock button for 2 seconds. At this point a red LED will illuminate on the button - Child Lock function is now active.

**To Remove Child Lock** - Press and hold the Child Lock button down for 2 seconds.

**NOTE:** - The Child Lock option will need to be removed before another programme can be selected.

## OPTIONS

---

Options are selected by pressing the button and confirmed by illumination an orange LED situated in the button.

If an option is not available with a programme, the LED will flash and a bleeping noise will be heard when pressing the button.



**TIME DELAY**



**MINI LOAD - MINI CARICO**



**EXTRA RINSE - EXTRA RISCIAQUO**



**EASY IRON - STIRA FACILE**

### **MINI LOAD**

For washing a smaller load.

In addition to reducing actual washing time, this option will reduce water and energy consumption by up to 50%.

NOTE: - You can reduce the amount of detergent you use with this programme.

### **EXTRA RINSE**

For large wash loads and items for young children or people with sensitive skin.

This option adds a rinse.

### **EASY IRON**

To reduce creasing to a minimum and save you ironing time.

### **TIME DELAY**

With this option you can delay the start time of the programme between 1 and 24 hours.

**DEMO MODE - ARXXF125EU**

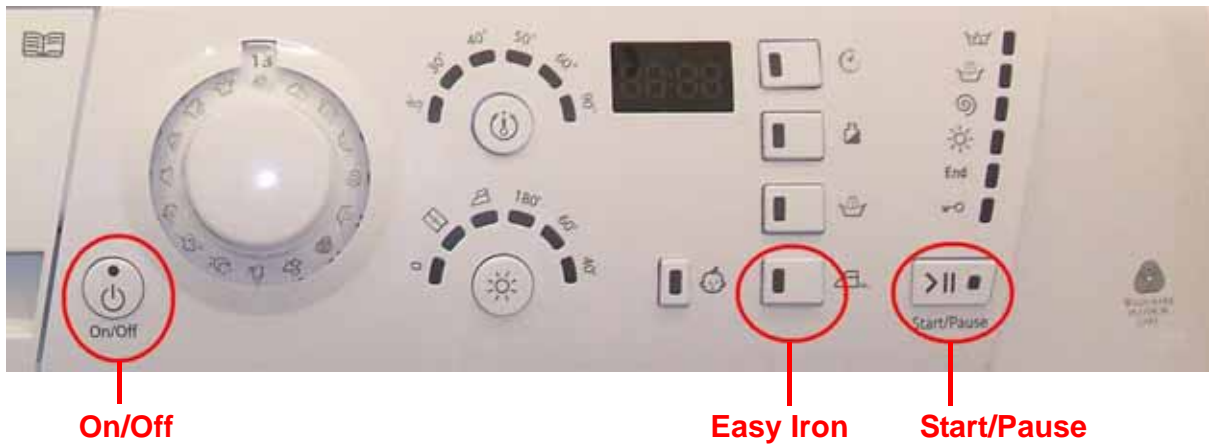

**To Activate Demo Mode**

Press and hold the following buttons simultaneously: -

- ON/OFF BUTTON
- EASY IRON
- START / PAUSE

**To De-select Demo Mode**

Press and hold the following buttons simultaneously: -

- ON/OFF BUTTON
- START / PAUSE



## CONTROLS INFORMATION

---

A single control board located at the back of the machine contains all the circuitry to control the machine and interfaces with the programme selector, option buttons and LEDs located on the console panel. The control board has an access port to the rear of the machine.

Programmes are selected by turning the rotary switch to one of the 16 positions. Special options can be selected by pressing the appropriate buttons and the programme process followed by LEDs.

The machine is switched on using the On/Off button and selected programmes started by pressing the Start/Cancel button.

### Automatic Features

---

#### Auto Half Load

Auto half load adjusts the amount of water in the wash load depending on the absorbency of garments in the wash load.

#### Fabric Conditioner Dispensing

Dispensing of fabric conditioner is achieved by energising both the Pre-Wash and Main Wash cold valves.

#### Out of Balance Protection

The machine has an inbuilt feature to prevent spinning with an unbalanced load. A calculation via the motor tacho and control board detects the current drawn by the motor during distribution.

Before each spin, the controls sense the load within the drum and if the load is calculated to be out of balance the machine will not automatically spin to the full speed.

There are two levels of out of balance, level 1 @ 480 grammes and level 2 @ 1030 grammes.

If the out of balance is below level 1 the machine will spin at full speed, if between level 1 and level 2 the machine will spin at the reduced speed of 600 rpm and above level 2 spin at reduced speed of 400 rpm. There are 15 attempts at level 1 with 57 attempts in total, this being the same for both cotton and synthetic spins.

The wool spin has one level of out of balance @ 1.8 kg. The controls will make three attempts to achieve a balance, if after three attempts a balance is not achieved; the spin is reduced to a speed of 90 rpm.

**OPTION AVAILABILITY**

PROGRAMME NUMBER	PROGRAMME DESCRIPTION	HALF LOAD	EXTRA RINSE	EASY IRON	TIME DELAY
1	COTTON 60°	YES	YES	YES	YES
2	COTTON COLOURFAST 40°	YES	YES	YES	YES
3	ACRYLICS 60°	YES	YES	YES	YES
4	DELICATE 40°	YES	YES	YES	YES
5	FRESH UP	*	*	*	YES
6	SANITARY 90°	YES	YES	*	YES
7	NIGHT CYCLE 40°	YES	YES	*	YES
8	BABY CYCLE 40°	YES	YES	*	YES
9	SILKS 30°	YES	YES	YES	YES
10	WOOL 40°	YES	YES	*	YES
A	HIGH RINSE	YES	YES	YES	YES
B	Delicate Rinse	*	*	*	YES
C	Long Spin	*	*	*	YES
D	Short Spin				
E	DRAIN				

**SPECIAL PROGRAMME DESCRIPTIONS****FRESH UP (15 MIN)**

**Load:** 1.5 kg  
**Cycle duration:** 15 minutes

Extra fast wash programme with the same performance of a 30° wash

**SANITARY**

**Load:** 6.5 kg  
**Cycle duration:** 3.5 Hours

90° programme that can use bleach together with the perfect rinse to remove Bacteria

**NIGHT CYCLE - Temperature 40°C - Spin 800 rpm**

**Load:** 4.0 kg  
**Cycle duration:** 4.0 Hours

This cycle is very silent and ideal to use at night due to the minimum use of the drain pump and reduced drum action with the added advantage of lower energy consumption. At the end of the cycle the washing will be suspended in water avoiding the main noise created during the final phase.

**BABY - Temperature 40°C - Spin 800 rpm**

**Load:** 2.0 kg  
**Cycle duration:** 1 Hour 50 minutes

This cycle will remove all residue of detergent from the clothes to cut down the risk of allergic reactions on delicate skin. It is also designed to reduce bacteria by using more water.

# WIRING DIAGRAM - SINGLE PHASE LED

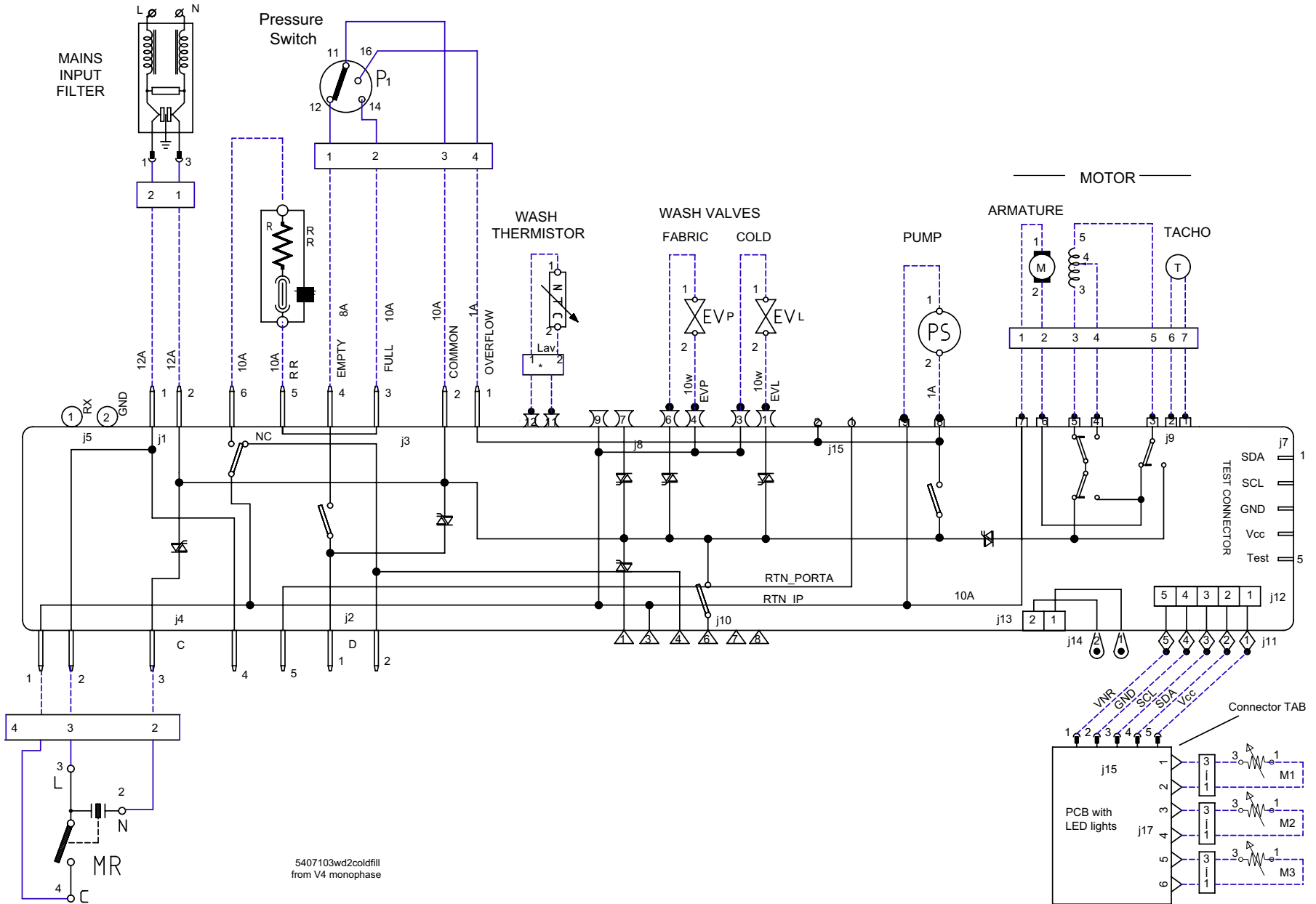

# WIRING DIAGRAM - SINGLE PHASE DIGIT

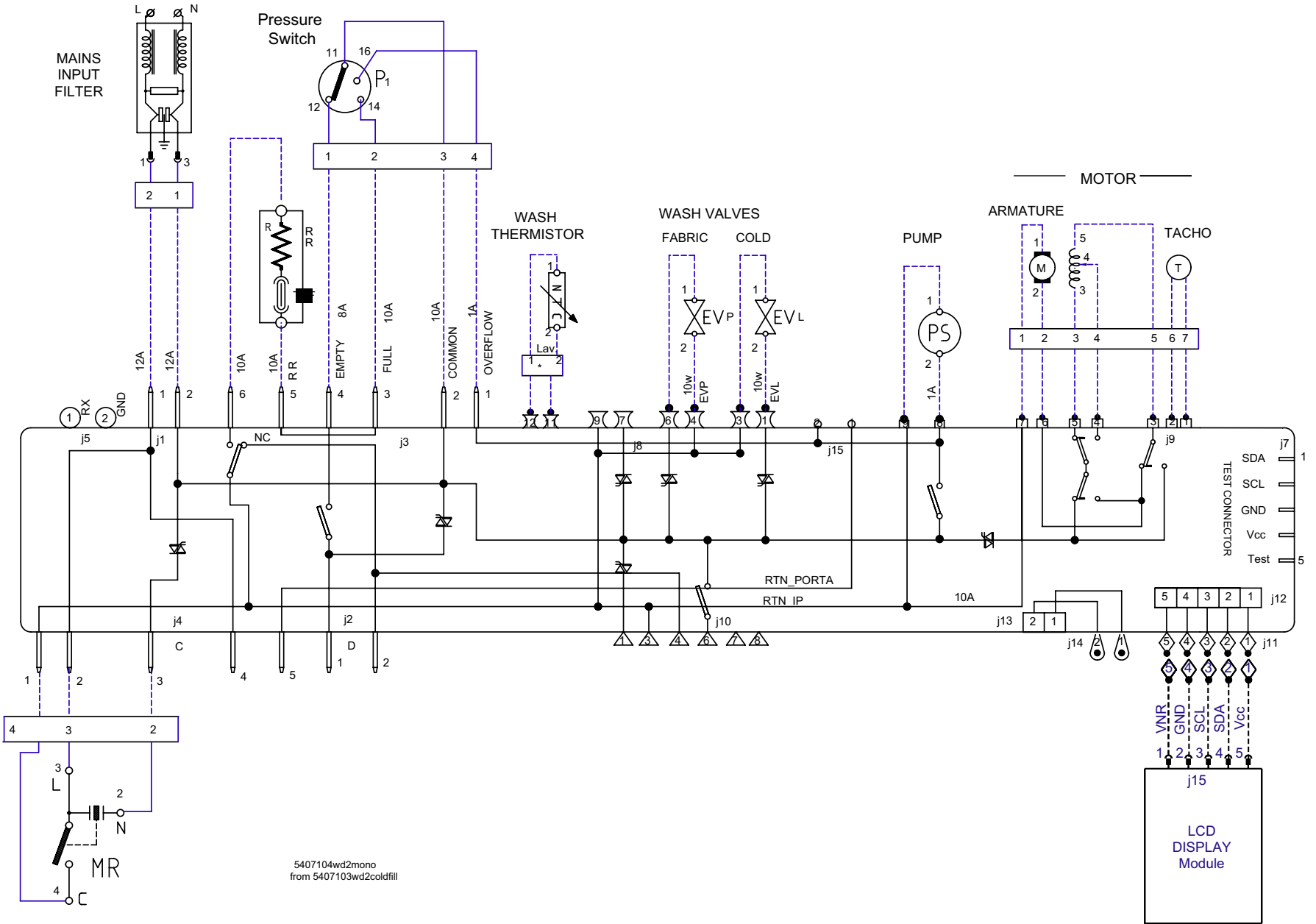

**WIRING CONNECTION CHART**

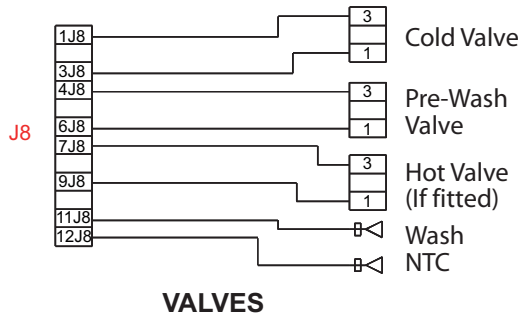
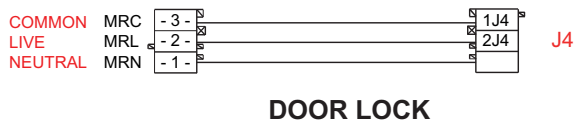
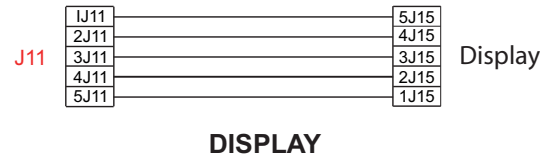
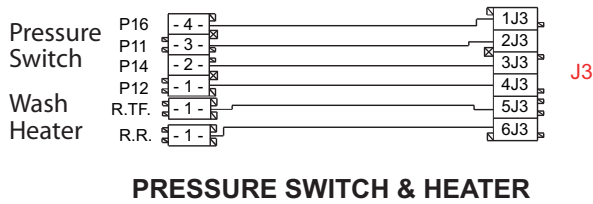
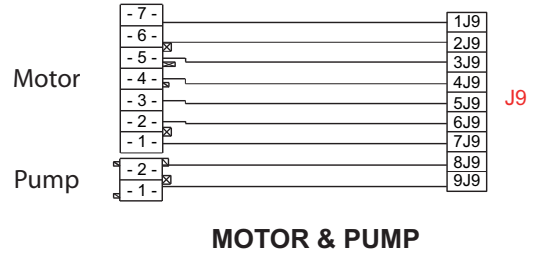

5407388wcc.ai  
from 16001769800

**WIRING LEGEND**

AQS	Aquastop solenoid valve	N	Neutral or Terminal board
B	Buzzer or Door lock	NC	No spin
BF	Terminal board contacts, dryer heating element	P	Pressure switch
BP	Door lock	P1	Pressure switch 1st level
C	Condenser	P2	Pressure switch 2nd level
AC	Condenser	PA	High speed potentiometer
DV	Switch	PB	Low speed potentiometer
EF/CL	Cold water/bleach solenoid valve	PL	Pure wool
EF/L	Cold water/wash solenoid valve	PM	Motor thermoprotector
EF/P	Cold water/prewash solenoid valve	PR	Timer programmer or Pressure switch
ER	Cut-out heater	PS	Drain pump
ET	Cut-out thermostat	R	Heating element
EV	Solenoid valve	Ras/RA	Drying heater
EVA	Drying solenoid valve	RE	Relay
EVC	Hot water solenoid valve	RR	Heating element
EVF	Cold water solenoid valve	RV	Speed regulator
EVL	Wash solenoid valve	S	Indicator light
EVP	Prewash solenoid valve	SL	Line indicator light
FA	Noise filter	SO	Door indicator light
FD	Delicate drying thermostat	SR	Heating indicator light
FE	Intense drying thermostat	ST	Temperature selector or Stop with water
FRT	Thermofuse resistance	SV	Spin speed selector
I	Reverser	T	Timer contacts
I1..I2..3.	Switches/deviators	TA	Drying timer contacts
IA	On/Off switch	TB	Low temperature thermostat
IC	Switch NC / 1/2 load	TC	Crosspiece earth
ID	No spin switch	TFL	Flange earth
IE	Water-economizer or NC Switch	TG	Main earth
IF	Spin decrease switch	TH	Thermostat
IP	Door switch	TH1	Thermostat 1st temperature
IR	Line switch	TH2	Thermostat 2nd temperature
IS	Water-stop	TH3	Thermostat 3rd temperature
L	Line or Lamp	THF	Work thermostat
LB	Low level	THR	Adjustable thermostat
LN	Normal level	TM	Motor earth
LS	Indicator light	TMB	Base cabinet earth
M	Earth symbol or Dryer motor	TMP	Motor thermoprotector
MC	Spin motor or Spin winding	TMS	Thermostop
MI	Induction motor	TP	Thermoprotector or Pump earth
ML	Wash motor or Wash winding	TPS	Drain pump earth
MO	Terminal board	TR	Heating element earth
MP	Door microswitch	TS	Safety thermostat or Support earth
MR	Microdelay device	TT	Timer earth
MT	Timer motor	TTH	Thermostat earth
MV	Fan	TV	Tub earth
MV - Ras	Dryer fan (RA)	ZBN	Timer
Mzbn/M	zbn timer motor		

**POWER MODULE CONNECTIONS**

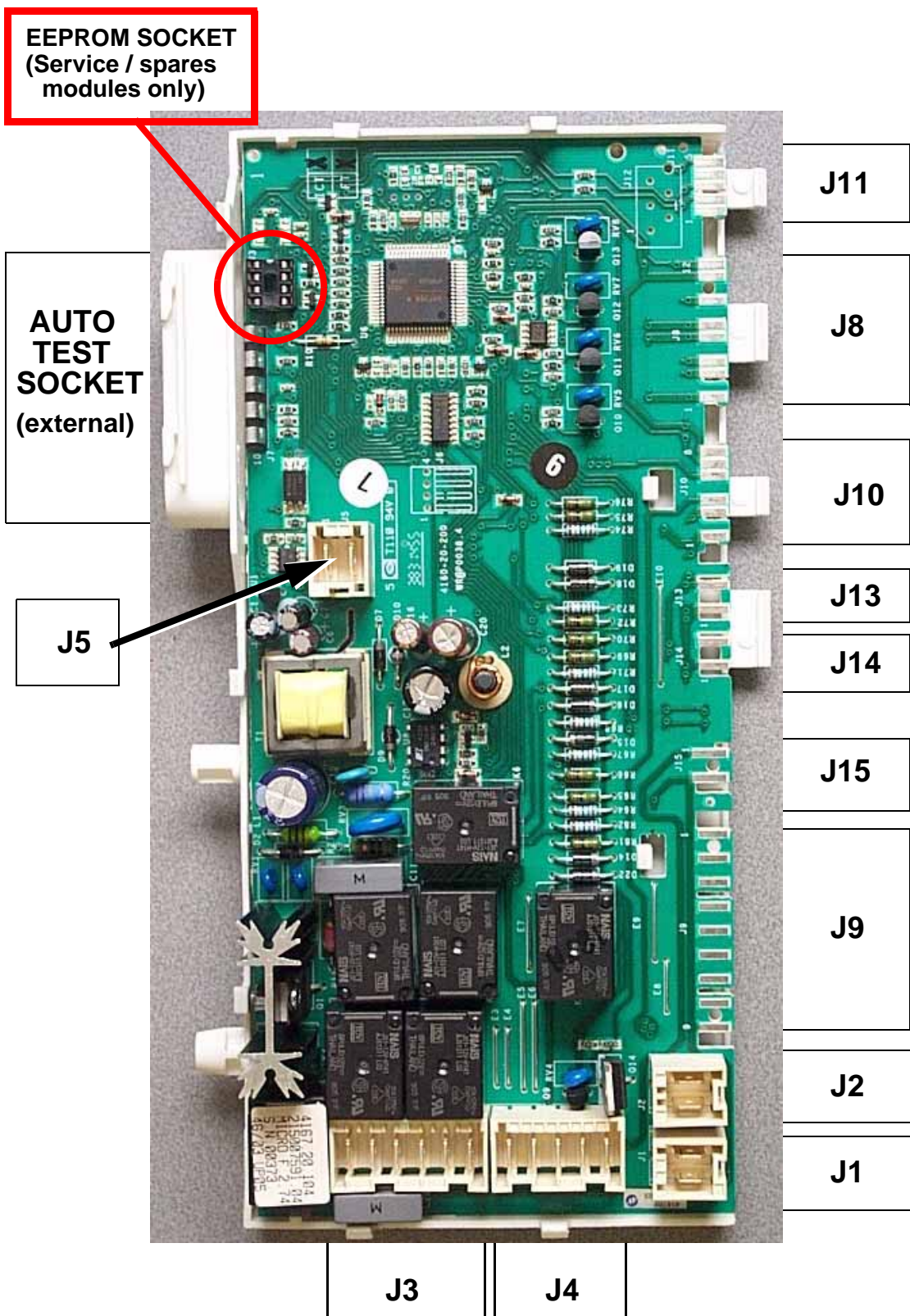

## ERROR CODES & POSSIBLE CAUSES

When an error occurs the following LEDs will flash indicating a fault.  
Refer to the chart below for the error code definitions.

### LED DISPLAY MODELS

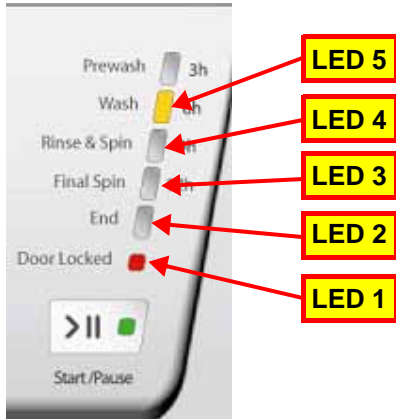

FAULT	LED COMBINATION				
	LED 5	LED 4	LED 3	LED 2	LED 1
F01	Off	Off	Off	Off	On
F02	Off	Off	Off	On	Off
F03	Off	Off	Off	On	On
F04	Off	Off	On	Off	Off
F05	Off	Off	On	Off	On
F06	Off	Off	On	On	Off
F07	Off	Off	On	On	On
F08	Off	On	Off	Off	Off
F09	Off	On	Off	Off	On
F10	Off	On	Off	On	Off
F11	Off	On	Off	On	On
F12	Off	On	On	Off	Off
F17	On	Off	Off	Off	On
F18	On	Off	Off	On	Off

### DIGIT DISPLAY MODELS



Fault Codes  
are Displayed  
here

F01	<b>Motor triac short circuit:</b> Check motor and module connections
F02	<b>Motor jammed / tacho detached:</b> Check motor and module connections
F03	<b>NTC short/open circuit:</b> Check thermistor and module connections
F04	<b>Pressure switch jammed on empty:</b> Check switch and module
F05	<b>Pressure switch jammed on full or pump blocked:</b> Check pump and switch
F06	N/A
F07	<b>Heater relay stuck:</b> Check heater and module connections
F08	<b>Heater relay stuck:</b> Check pressure switch, heater and module connections
F09	<b>Setup error:</b> Check Eeprom
F10	<b>Pressure switch not sensing:</b> Check switch and module connections
F11	<b>Pump cannot be activated:</b> Check pump, connections and wiring
F12	<b>No communication between cards:</b> Check module connections
F17	<b>Door lock error:</b> Check door, door lock and module connections
F18	<b>Communication error (3 phase motor):</b> Replace power board



## DISMANTLING INSTRUCTIONS

### SAFETY NOTES

1. Ensure that the appliance is disconnected from the electrical supply before dismantling.
2. Beware of sharp edges on metal panels, plastic mouldings, and pressed parts.
3. Some fixings (especially those into plastic) must be tightened to the correct specification using a suitable torque wrench.
4. Insulation resistance tests must be carried out with the pressure switch set to ensure that the water heater is 'in-circuit' during the test.

#### A Table Top

1. Remove the two screws at the top rear of cabinet.
2. Slide the table top backwards to disengage the location fixings at the rear and lift off.

#### B Lower Rear Access Panel

1. Remove three screws from the lower rear access panel.
2. Pull the top edge of the panel out and disengage it from its location fixings along the bottom.

#### C Dispenser Drawer

1. Open the dispenser drawer fully.  
Gently lift slightly and pull. See right.

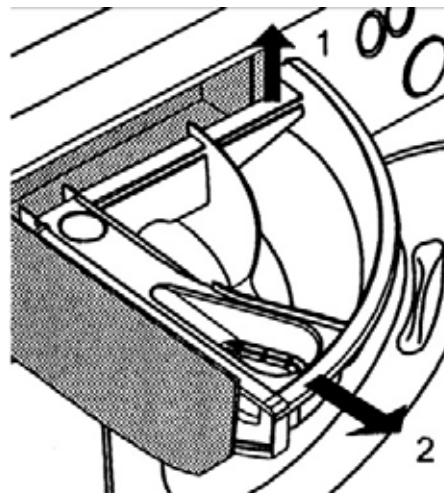

#### D Console Panel

1. Remove the table top (A).
2. Remove the dispenser drawer (C).
3. Remove two top screws securing the panel to the cabinet and two screws securing the panel to the dispenser.
4. Unplug the wiring from the cabinet side to the console PCB - taking note of position.
5. Remove two screws from the valve support plate and move the dispenser to the rear.
6. Unclip two plastic lugs securing the console panel to the front panel and lift clear.
7. Avoid unclipping and handling the control board unless absolutely necessary, as the control board is susceptible to static electricity.

### **E Console PCB**

1. Remove the console panel (D).
2. Remove the wiring plug - taking note of position.
3. Remove the four securing screws.

### **F Timer Knob, Programme Dial & Potentiometer**

1. Push the timer knob to release it to the operating (out position) then pull knob firmly. Note: this knob has keyed slots to determine position for replacement.
2. Remove two screws securing the selector switch plate and carefully unclip the programme dial.

### **G Option Knobs & Potentiometer**

1. Push the knobs to release them to the operating (out position) then pull the knob firmly from the 'D' shaft.
2. Carefully unclip the relevant potentiometer.

### **H(a) Pressure Switch**

1. Remove the table top (A).
2. Disconnect the wiring connection block and pressure hose.
3. Carefully unclip the bracket from the cabinet side and then unclip the switch from the bracket.

### **H(b) Front Panel**

1. Remove the table top (A), dispenser drawer (C) and console panel.
2. Remove the door seal restraint (I) and door interlock (J).
3. Grip the appliance kickstrip at both ends and pull it off in a forward direction.
4. Remove 4 front panel fixing screws (2 bottom, 2 top).
5. Slide the dispenser housing backwards so that it clears the console backplate opening.
6. Lift the front panel upwards to disengage the four cabinet fixing pegs and lift off.

### **I Door Seal & Restraint:**

#### **1. Door Seal to Front Panel Fixing**

The door seal is fixed to the cabinet front panel by a wire clamp and a small spring. The spring is normally at the bottom of the door.

Carefully place a small screwdriver into one of the lugs of the spring and by stretching the spring the wire band can be removed.

#### **2. Drum Fixing**

The door seal is fixed to the drum with a zipper retainer. After removing the front panel (Hb) remove the zipper as shown in Fig. 1 overleaf.

On refitting place the strap around the door seal and tighten as shown in Fig. 2. Observe correct seal and zipper fixing positions as shown in Fig. 3 and Fig. 4.

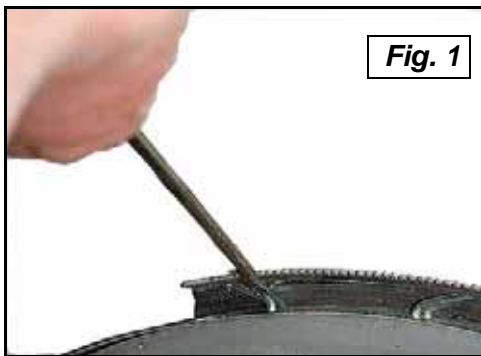

Seal to Drum fixing position

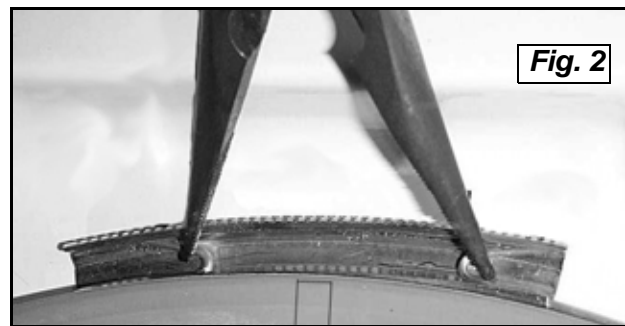

Correct Zipper & Seal position at Drum Front

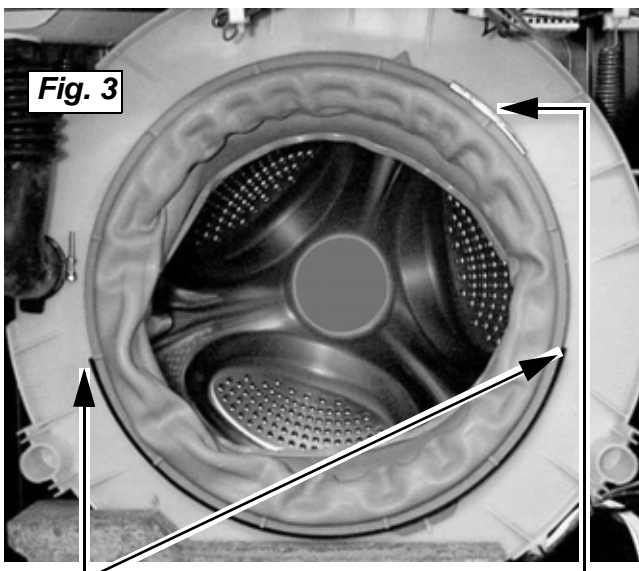

Plastic Support  
(observe position)

Zipper

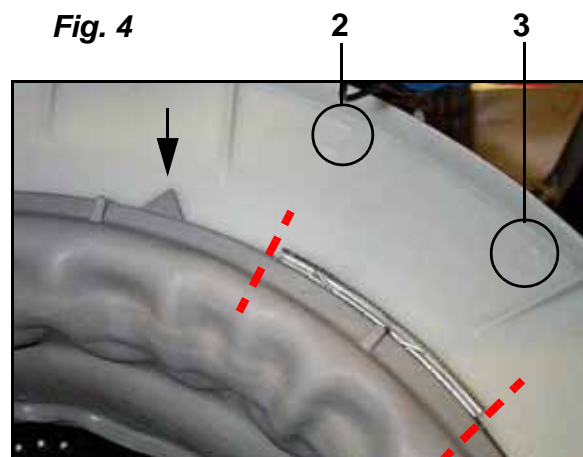

Fig. 4

### J Door Interlock

1. Remove the door seal restraint (G).
2. Peel the door seal off the front panel, and fold it back into the inner drum.
3. Remove 2 screws from the interlock.
4. The interlock can now be eased out, allowing access to the wiring connection block and emergency release strap.
5. Care must be taken to ensure the correct orientation of the wiring connection plug to prevent seriously damaging the interlock and / or control board.



## K Door Assembly

1. Open the door through 180° and remove four screws securing the hinges to the front panel. Ease the hinges from the panel.
2. The door trims can now be split. Lay the door assembly face down on a suitably protected surface and remove 6 screws securing the two halves of the door.
3. Unclip the two halves at the hinge end and separate a sufficient distance to slide out the door glass.
4. When removing the hinges, note the orientation. To remove, fold hinges inward, slide towards each other to release other end. See photo. Reassemble in reverse order.
5. To fully separate the halves, slide the front away from the handle.
6. To remove the handle or latch, slide securing pin out noting the position of the spring and latch.

**Top Hinge removal** (shown below) - Slide towards lower hinge, twist to the left and slide up to release.

**Lower Hinge removal** - Slide upwards, twist to the right and slide down to release.



## L Front Panel

1. Remove the table top (A), dispenser drawer (C) and console panel (D).
2. Remove the door seal restraint (I) and door interlock (J).
3. Grip the appliance kickstrip at both ends tilt forwards, and pull it off in a forward direction.
4. Remove 4 front panel fixing screws (2 bottom and 2 top).
5. Slide the dispenser housing backwards so that it clears the console backplate opening.
6. Lift the front panel upwards to disengage the four cabinet fixing pegs, and lift off.

## M Door Seal

1. Remove the table top (A), dispenser drawer (C) and console panel (D).
2. Remove the door seal restraint (I) 1 and 2, door interlock (J) and front panel (L).

## N Drive Belt

1. Remove the table top (A).
2. Remove the lower rear access panel (B).
3. Carefully peel the belt off the motor pulley taking care not to trap fingers and using suitable protection against sharp edges.
4. To refit the belt, place it round the motor pulley first, tie-wrap the belt onto the drum pulley, and rotate the drum from the door aperture to move the belt into position.
5. Ensure any remaining tie-wraps are removed.  
It is essential for continued safety that only a genuine spare is fitted. The belt is electrically conductive and provides an electrical earth to prevent static built up on the inner drum assembly.

**P Motor**

1. Remove the lower rear access panel (B) and drive belt (N).
2. Disconnect the motor wiring connection plug and earth wire.
3. Disconnect the heater and NTC.
4. Using a 10 mm socket, remove both motor mount fixing screws. Fig. 5.
5. Carefully ease the motor off the drum mountings.
6. Slide the motor to the left and lift out of the back of the aperture. Fig. 6.
7. When replacing the motor fixing screws ensure that they are tightened to 9 Nm.



**Q(a) Lower Balance Weight**

1. Remove the table top (A), dispenser drawer (C) and console panel (D).
2. Remove the door seal restraint (I), door interlock (J) and front panel (L).
3. Using a 13 mm socket or spanner, remove three balance weight fixing screws.
4. Pull the weight forward off its mounting lugs.
5. When refitting the balance weight it is essential to ensure that the thread forming screws are tightened to 24Nm (using a suitable torque-wrench) and that the screws find their original threads, otherwise the thread can be stripped from the plastic drum lug.

**Q(b) Top Balance Weight**

1. Remove the table top (A).
2. Using a 13 mm socket or spanner, remove three balance weight fixings screws.
3. Lift the weight off the drum mountings.
4. When refitting the balance weight it is essential to ensure that the thread forming screws are tightened to 24Nm (using a suitable torque-wrench) and that the screws find their original threads, otherwise the thread can be stripped from the plastic drum lug.

<b>6 kg Welded Drum</b>				
Torque Setting 24 Nm				
Sequence	Top Weight	1	2	3
	Bottom Weight	1	2	3

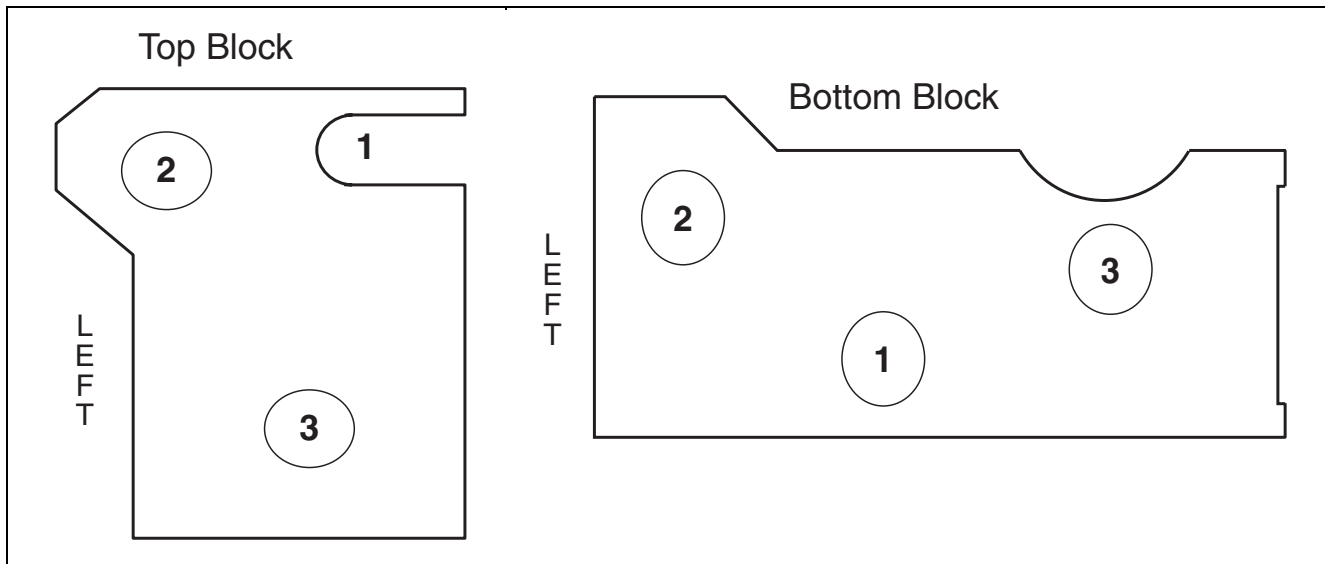

### R Heater / Thermistor

1. Remove the rear lower access panel (B).
2. Remove the heater wiring and detach the thermistor plug.
3. Slacken off the 10 mm heater fixing nut and withdraw the heater from the drum.

### S Drum Pulley

1. Remove the complete drum assembly (X).
2. Carefully peel the belt off the motor pulley taking care not to trap fingers.
3. Use the pulley locking tool to prevent rotation of the pulley.
4. Use a Torx T40 bit to partially remove the fixing screw in the centre of the pulley, and strike the head of the screw with a copper mallet to release the pulley from the shaft.
5. To ensure adequate pulley security always apply an engineering Nutlock (Part No. 981009) to the bolt threads.

### T(a) Suspension Damper

1. Remove two suspension clamp fixing screws.
2. Remove the table top (A), dispenser drawer (C) and console panel (D).
3. Remove the door seal restraint (I), door interlock (J) and front panel (L).
4. Remove the lower balance weight (Ma) if access is required to the left-hand damper.
5. Unclip any wiring retained within the integral clip on the bottom damper moulding.
6. Remove the plastic peg securing the damper to the outer drum using special tool Part No. 5600198.
7. Unclip the suspension clamp from the chassis.  
Withdraw the suspension damper.

**Note: The suspension unit should not be split and is not serviceable.**

8. When reassembling, fit a new plastic peg if the locking-tab on it shows signs of damage.

## T(b) Suspension Spring

1. Remove the table top (A).
2. Unclip any wiring retained within the integral clip on the spring bearing keeper plate.
3. Gently lever out the bearing keeper plate with a small flat bladed screwdriver.
4. Unhook the spring from the cabinet top rail bearing.

## U Dispenser

1. Remove the table top (A) and dispenser drawer (C).
2. Remove two screws around the dispenser recess.
3. Remove the screw securing the valve to the valve cover.
4. Remove the screw securing the valve cover to the cabinet and remove the cover.
5. Ease the dispenser backwards.
6. Remove the dispenser inlet and outlet hoses, and any harness retention ties.

## V Drain Pump

1. Remove the appliance kick strip by gripping it at both ends, tilt it forwards and pull it off towards you.
2. Remove the 2 pump housing fixings screws from the front panel. Rotate the pump to release the fixing lugs. See Fig. A below.
3. Slide the pump out through the base of the machine. See Fig. B below.
4. Detach the sump hose from the pump, using a suitable container to catch any water.
5. Disconnect the drain hose from the pump unplug the wiring connection block.

**Fig. A**  
Remove screws & rotate clockwise



**Fig. B**  
Remove pump through base of cabinet



## W Inner Drum Lifter

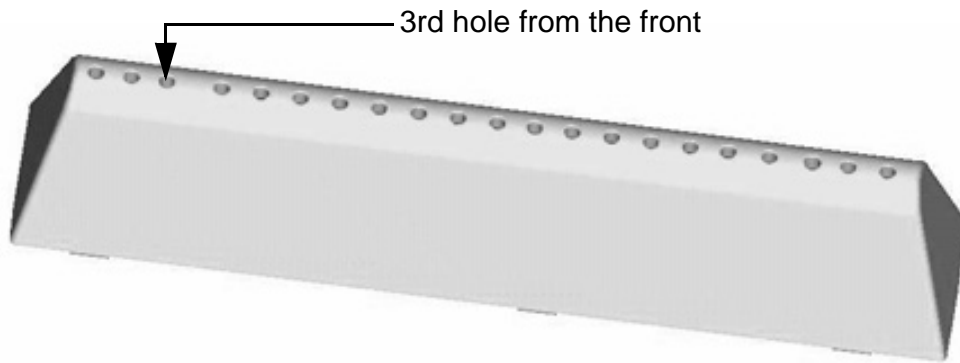

1. Insert a small screwdriver onto the 3rd lifter hole from the front of the drum. This will depress the drum flap securing the lifter.
2. Slide the lifter to the front of the drum and remove.
3. Before refitting, lift the drum locking tab 3 mm above the drum surface.
4. Offer the lifter to the holes in the drum, slide lifter to the back of the drum until a click is heard as the lifter is locked into place.

## X Drum Assembly

**Note: This sealed drum assembly cannot be split to remove or repair the inner drum, bearing support or bearings.**

**It must be replaced as a complete unit.**

**External components such as weights, bolts and hoses, motor and belt etc. will need to be transferred from the faulty drum assembly.**

1. Remove the table top (A).
2. Remove the top balance weight (Qb).
3. Remove the dispenser drawer (C).
4. Remove the console panel (D).
5. Remove the dispenser (U).
6. Remove the front panel (L).
7. Remove the lower balance weight (Qa).
8. Remove the lower rear access panel (B).
9. Disconnect heater / thermistor wiring and release the wiring harness from the drum clips.
10. Detach the drum from the damper units by removing the two plastic pegs using special tool Part No. 5600198.
11. Remove the sump hose fixing clip and detach the sump hose from the sump chamber.
12. Unclip any wiring retained within the integral clip on the spring bearing keeper plates.
13. Gently lever out the spring bearing keeper plates with a small flat bladed screwdriver.
14. Unhook springs from the cabinet top rail bearings.
15. Carefully lift the drum assembly out of the cabinet whilst supporting the drum.



## Y Cabinet

1. Remove the table top (A).
2. Remove the dispenser drawer (C) and console panel (D).
3. Remove the front panel (L).
4. Remove the lower balance weight (Qa).
5. Remove the lower rear access panel (B).
6. Remove the motor (P).
7. Remove the top balance weight (Qb).
8. Remove the drum assembly (X).
9. Remove the drain pump (V).
10. Unscrew feet, remove the wheels, and remove hose clips from the rear of the cabinet.

## Z Power Module

1. Remove lower rear access panel (B).
2. Remove screw or screws securing module support to the cabinet.
3. Disconnect the wiring.

### IMPORTANT NOTE - AVOIDING ELECTRICAL DAMAGE TO THE MODULE

Before disconnecting any plugs it is advisable to note their locations.

When reconnecting the plugs to the module it is **essential** that the large WHITE multiway edge connector plug is fitted with the wires from the plug oriented as shown on the NEXT page.

Applying power to the machine with the plug fitted in the wrong position WILL CAUSE PERMANENT DAMAGE to the module.

## Correct Motor Plug / Module Orientation

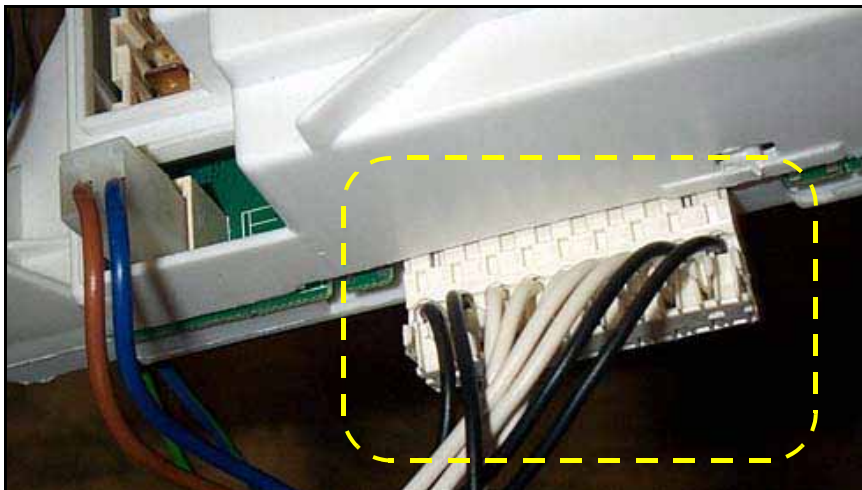

**White Multiway  
Connector Plug**

**Wires must exit the  
plug as shown here**

**Ensure correct  
orientation when  
refitting**

4. Lift module clear.
5. When replacing the board an EEPROM will also be required.  
Service modules are not normally supplied with a programmed EEPROM.

**Note:** To remove and fit the EEPROM use Insulated Tweezers Part No. C00066292 as shown overleaf.

On the original control board, the EEPROM may be soldered to the board and cannot be removed.

## IC Removal Tool

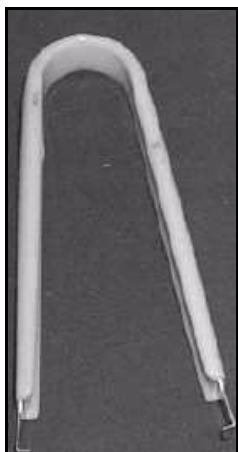

## EEPROM Removal from PCB

