

Product Model Number
WDC7100XC
Splendide WDC7100XC Laundry Center

Specifications:

- Weight: 148 lbs.
- Dimensions: 23.4"W x 33-33.4"H x 22.6"D (see right)
- Capacity: Wash - 2 to 15 lbs / Dry - 2 to 11 lbs.

Electrical Requirements:

- Volt/Amp/Hz: 120V, 11 Amp, 60 Hz.
- Maximum Absorbed Power: 1300 Watts
- Connection: 3-prong plug with 6' cord provided.
- Circuit/Protector: 3-wire single phase, 120V, 60Hz, AC, on a separate 15-ampere circuit.

Water Connections:

- Maximum Pressure: 0.69 MPa (6.9 bar), 100 PSI
- Minimum Pressure: 0.05 MPa (0.5 bar), 7.5 PSI

Installation Location:

- Unit may be installed in recessed area, closet, or alcove.
- Air Space Requirements: 0" on sides and 1" in front and back (from the case). Additional installation spacing needs to be considered for easy installation, servicing, and compliance with state and federal codes.
- Floor must support at least 280 lbs. and be a solid, level surface.
- When locating in a towable trailer or watercraft, position the machine over the axles or midship where movement is at a minimum. Block unit in to prevent extreme movement.
- Splendide #MK01 SecureFit Bracket kit available to prevent shifting in RV and Marine installations.

Standpipe Drain System / Sink Draining Req:

- Needs a 1 1/4" (3.2 cm) minimum diameter standpipe with the minimum carry-away capacity of 7 gallons (26 liters) per minute. Top of standpipe must be at least 25" (62 cm) high and no higher than 34" (86 cm) from the bottom of the washer.
- Outlet end of drain hose (provided with the unit) must be at least 20" above bottom of washer. An air break must be available at the standpipe to avoid siphoning.
- Faucet Adapter Kit #154187104A is available to allow for direct faucet connection. See complete installation instruction on drain hose draining directly into sink, connection to dishwasher Wye fitting, and disposer/drain connection in owners manual.
- Optional Drain-A-Way™ Pans are available. Pan #PI-22 for cabinet or undercounter installations. Pan #P-24 for freestanding installations. Both are designed to be drain plumbed.

NO DRYER VENT REQ. ON THIS MACHINE:



- This machine incorporates an internal condenser for drying. All humidity stays within the unit and is drained as water. No heated or air conditioned air is exhausted outside, so no vent is needed. This not only conserves energy, but also avoids problems with the delicate air balance requirements in large multifamily complexes.

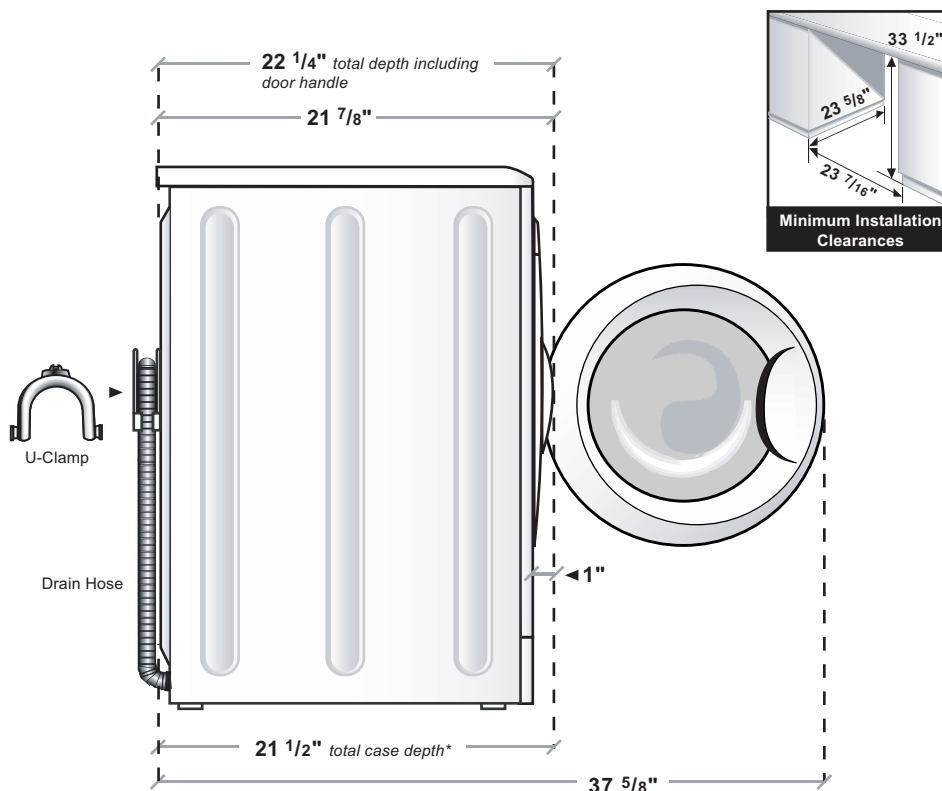

Side View (not to scale)

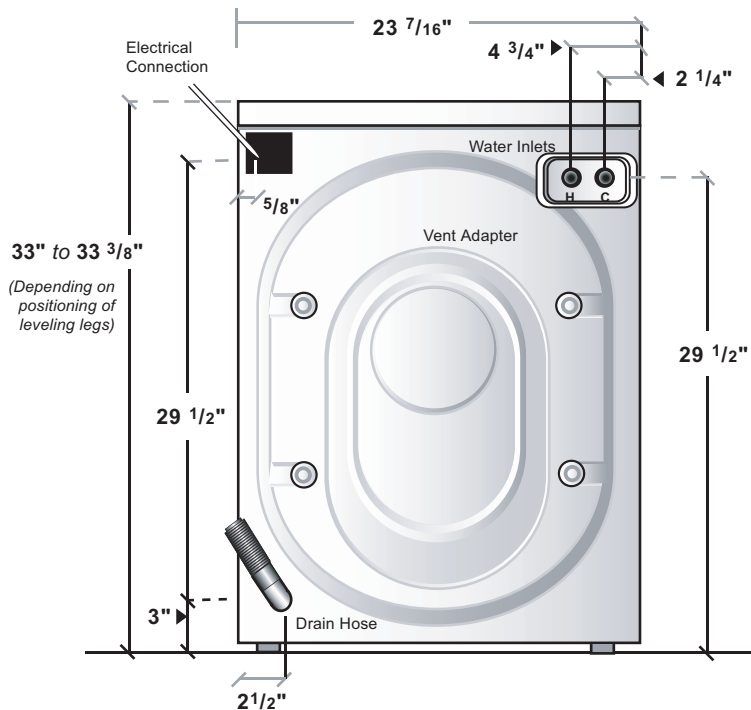

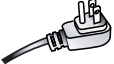
Rear View (not to scale)



| Included | | |
|---|---|---|
|  |  |  |
| 2 Water Inlet Hoses | Electrical Connection (6' cord length) | Flexible Drain Hose (5' length) |

| Sold Separately | |
|---|---|
|  |  |
| Drain-A-Way Pan #PI-22, P24 | SecureFit Bracket Kit #MK01 (for RV/Marine installations) |