

OWNERS MANUAL

Splendide

When Technology Meets Ecology

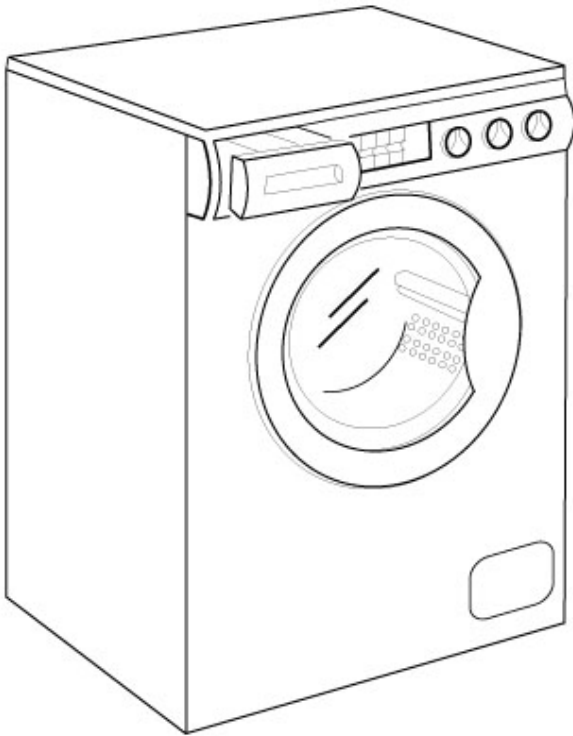

CAUTION:

Before operating this appliance it is recommended that you read this manual and follow all Safety Rules and Operating Instructions.

COMBINATION WASHER & VENTED DRYER MODEL WD802M



corporate offices

Westland Sales / PO Box 427 / 15650 SE 102nd Ave / Clackamas, OR 97015 - USA

warehouses Clackamas, OR & Elkhart, IN / **phone** 503.655.2563 / **fax** 503.656.8829

web www.westlandsales.com / www.splendide.com / e-mail splendide@westlandsales.com

TABLE OF CONTENTS

Splendide LAUNDRY CENTER

Record Serial & Model Number.....	1	Line Drawing and Images.....	8
Installation.....	2	How To Wash.....	9
Removing Shipping Brackets.....	2	Operating Steps.....	9
Leveling.....	2	Your First Load.....	9
Grounding.....	2	Pre-Wash.....	9
Plumbing.....	3-4	How To Use Your Washer.....	10
Exhausting.....	4	Tumble Dry.....	10
Important Safety Instructions.....	4	To Rinse, Spin and Tumble-Dry...	10
Recessed, Closet and Alcove Installation.	5	Wash Table.....	10
Laundry Preparation.....	6	Laundry Aids.....	11
Sorting.....	6	Detergent Recommendations.....	11
Inspection.....	6	Bleaches.....	11
Pre-Treating.....	6	Liquid Fabrics Softeners.....	11
Pre-Washing.....	6	Stain Removal Chart.....	11-12
Laundry Aids.....	6	Care and Cleaning.....	13
Washer Features.....	7	Cleaning the Exterior.....	13
On-Off Button.....	7	Cleaning the Interior.....	13
Medium/High Spin Button.....	7	General Maintenance.....	13
High/Heat Half/Heat Button.....	7	Cleaning the Drain Screen.....	13
Wash Timer.....	7	Winterizing.....	13
Water Cycle Selector.....	7	Avoid-Service Check List	13-14
Drying Timer.....	7		
Cool Drying Period.....	7		
Drain Screen.....	7		
Detergent Dispenser.....	7		

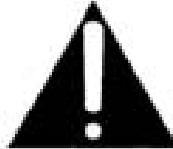
	CAUTION RISK OF ELECTRIC SHOCK DO NOT OPEN	
	CAUTION: TO REDUCE THE RISK OF ELECTRIC SHOCK. DO NOT REMOVE COVER (OR BACK). NO USER SERVICEABLE PARTS INSIDE. REFER SERVICING TO QUALIFIED SERVICES PERSONNEL.	



The lightning flash with arrowhead symbol, within an equilateral triangle, is intended to alert the user to the presence of uninsulated "**Dangerous Voltage**" within the product's enclosure that may be of sufficient magnitude to constitute a risk of electric shock to persons.



The exclamation point within an equilateral triangle is intended to alert the user to the presence of important operating and maintenance (servicing) instructions in the literature accompanying the appliance.

The model number of this product may be found on the back of the unit; and the serial number on the label affixed to the back of the unit.

You should note the model and serial numbers of this unit in the space provided, and retain this booklet as a permanent record of your purchase to aid in identification in the event of theft.

MODEL NUMBER _____

SERIAL NUMBER _____

WARNING:

TO PREVENT FIRE OR SHOCK HAZARD, DO NOT EXPOSE THIS PRODUCT TO RAIN OR MOISTURE.

USE AND CARE OF YOUR AUTOMATIC WASHER-DRYER TO AVOID UNNECESSARY SERVICE CALLS

Your new appliance is a carefully engineered product. Many times what appears to be a reason to call for service, requires nothing more than a simple adjustment you can easily make in your own home.

You will be charged for a service call while the appliance is in warranty if the problem is not caused by defective product workmanship or materials covered by this warranty.

To avoid a charge for an unnecessary service call, and before calling a serviceman, please refer to the **Avoid Service Check List** for situations that you can remedy. This list is included at the back of this Use and Care Book.

This appliance is an automatic washer-dryer. It is front loading, with an extra large door opening for easier access. It has 5 wash cycles in addition to extra rinse and extra spin cycles.

You will obviously want to obtain the best possible wash. By reading and following the instructions in this booklet you will achieve excellent results.

Please ensure that the instructions are followed. If you should need any further advice or assistance please contact the dealer where your machine was purchased.

BEFORE USING WASHER-DRYER

- The washer must be installed on a strong level floor, and in a protected, dry, and well-ventilated area close to a power and water supply of sufficient capacity, and a sufficient drain outlet.
- Dryer installation and grounding should be done in accordance with local codes by a qualified installer.

- "Installation Instructions" are included in your Use and Care Manual for the installers reference.
- The washer should be plugged into a properly grounded three (3) prong electrical outlet of 115 Volt, 1300W, 12.5 A, 60 Hertz. It should not be controlled by a wall switch or pull cord which might be turned off accidentally.

IMPORTANT

In the accessories bag you will also find a spanner that is to be used for removing brackets and leveling washer-dryer feet.

REMOVE SHIPPING BRACKETS

1. Remove back panel screws and lift panel clear (Fig. 1, Item A).
2. Remove fixing screws from the four brackets and cross bearing (Fig. 2, Item Y) then remove brackets.
3. Fix back panel with 3 screws previously removed (Fig. 1, Item A).
4. Close the 4 holes on the cabinet with the plastic blanking plugs that you will find in the accessories bag (Fig. 2, Item X & Z).

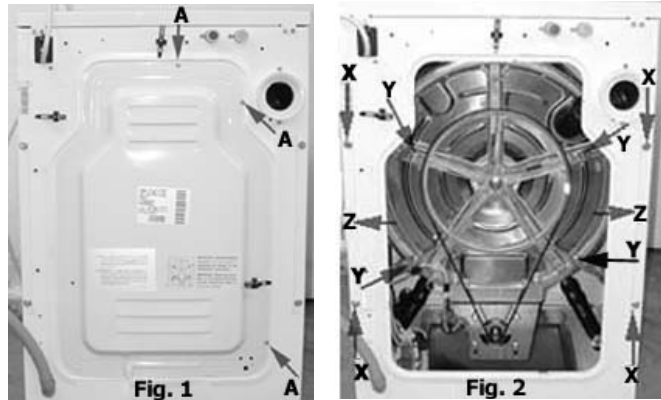

Leveling

After selecting a permanent location, the machine should be properly leveled to prevent vibration. To do this, adjust one or both front levelers, as needed, after loosening the lock nuts. Once your washer is perfectly leveled, be sure to tighten the lock nuts (Fig. 3).

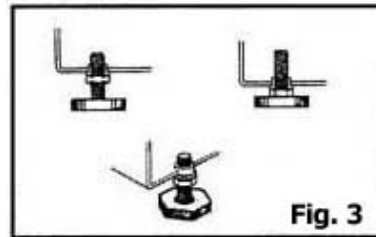

FOR YOUR OWN PROTECTION, AND TO PREVENT ACCIDENTS, INJURY AND FIRE, PLEASE READ THE FOLLOWING CAREFULLY:

- Destroy the carton and plastic bags after the washer-dryer has been unpacked.
- Children should never be left alone or unattended in the area where appliances are located.
- Washer installation and grounding must be done in accordance with local codes by a qualified installer. Installation instructions are included in this manual for the installer's reference.
- Use only low sudsing detergents suitable for front loading washers, or a small amount of regular detergent. The soap suds should never exceed the mid-line of the port-hole.
- The washer must be plugged into a properly grounded three (3) prong electrical outlet. For your safety, the third or round grounding prong must never be removed. DO NOT USE AN EXTENSION CORD.
- Repair or replacement of a part should be made only by a qualified service technician to prevent personal injury or damage to the machine. Ask your dealer for a list of authorized repair service companies.
- Disconnect power to the washer at the circuit breaker or fuse box, or unplug the machine in an emergency, or when servicing is required. Have the installer show you and label the proper switch or fuse at the electrical disconnect box.

WARNING - The Appliance Should Be Connected To An Individual Branch Circuit With No. 14 AWG Wire And Protected By 15 A Fuse or Breaker.

GROUNDING INSTRUCTIONS

This appliance must be grounded. In the event of malfunction or breakdown, grounding will reduce the risk of electric shock by providing a path of least resistance for electric current. This appliance is equipped with a cord having an equipment-grounding conductor and a grounding plug. The plug must be plugged into an appropriate outlet that is properly installed and grounded in accordance with all local codes and ordinances.

WARNING - Improper connection of the equipment-grounding conductor can result in a risk of electric shock. Check with a qualified electrician or serviceman if you are in doubt as to whether the appliance is properly grounded. Do not modify the plug provided with the appliance.

If it will not fit the outlet, have a proper outlet installed by a qualified electrician.

PLUMBING (Water Inlet)

The straight end of these hoses should be connected to the supply (Fig. 4). The 90° angled end of these hoses should be connected to the inlet valves on the back of the machine, using one of the washers to make a water tight seal on each connection. The couplings should be tightened by hand, a tool should only be used if a leak occurs. Do not use excessive force (see M, Fig. 5).

The Inlet valves are color-coded:

- Red = Hot
- White = Cold

It is possible to run the machine on cold water only, but a water supply must be connected to each inlet valve. To do this we suggest you use "F" connector, supplied with the washer-dryer (see N, Fig. 6).

PLUMBING (Water Outlet)

You should carefully position the drain hose to avoid kinks and ensure proper drainage of the water.

The outlet end of the drain hose must be at least 20" (50 cm) above the base of the machine. At this point it is possible for the water to be discharged into a sink, standpipe or drainpipe.

No more than 6" of the drain hose should insert into a standpipe. Assure an air break is available to prevent the machine from siphoning in a standpipe.

IMPORTANT

Make sure the drain hose is not kinked and the water flow is not restricted.

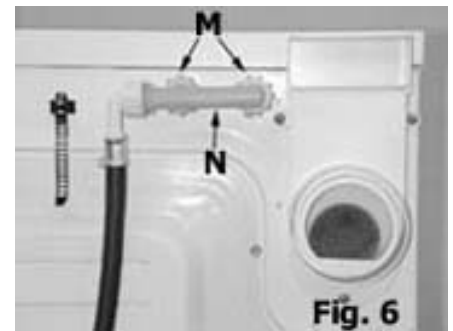
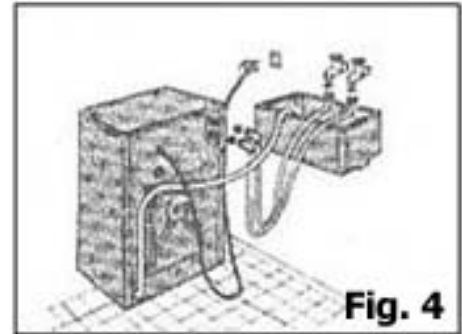

Standpipe Drain System:

When a standpipe installation is used it must be at least 1¼" (3.2 cm) in diameter with a minimum carry away capacity of 7 gallons (26 liters) per minute.

Wall or Floor Standpipe Drain:

Top of standpipe must be at least 25" (62 cm) high and no higher than 34" (86 cm) from bottom of washer (A & B).

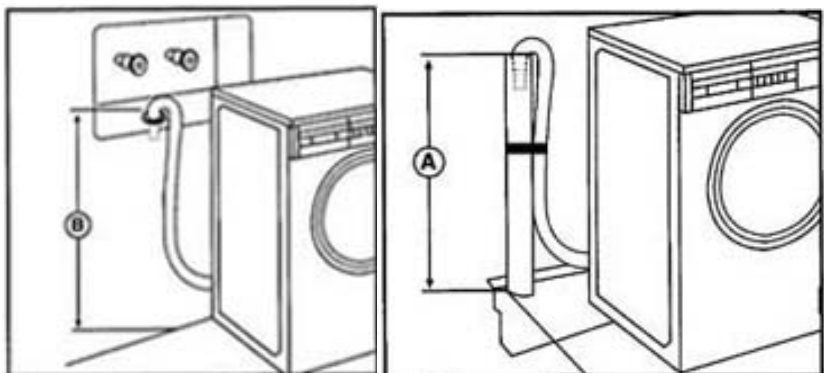

Sink Drainpipe System:

You should carefully position the drain hose to avoid kinks and ensure proper drainage of the water. Use a drain loop or suitable clamp to support drain hose at 25" (62 cm) minimum 34" (86 cm) maximum. The outlet end of the drain hose must be at least 20" (50 cm) above the base of the machine. Entry into sink drain system must be above trap. When routing the drain hose through cabinets or walls assure no ruff or sharp edges can damage the drain hose. All sharp edges **MUST** be covered by a protective material such as electrical or duct tape. Use a drain hose clamp to secure drain hose to "Wye" Branch or Disposer (not included).

- You may connect directly to a "Wye" Branch Tailpiece available at most hardware stores.
- You may connect directly to a Disposer by following the manufacturer attachment method.
- You may connect directly through the floor to a separate trap. The trap must be vented to prevent siphoning. To provide proper venting; install an Air Gap Kit available at most hardware stores.
- You may connect to the manufacturers sink drain kit (sold separately) that will supply water from your faucet and discharge water directly into your sink.

EXHAUSTING

The appliance should not be exhausted into a chimney, wall, ceiling, or any concealed space of a building. Only rigid or flex metal/metallic duct should be used for exhausting, unless the appliance has been investigated for use with non-metal/metallic duct (See Fig. 7).

To prevent large amounts of lint and moisture from accumulating and to maintain drying efficiency, consider exhausting outdoors.

OPTIONAL AIR OUTLET FILTER

The optional air outlet filter (Fig. 6 Page 3) is included as an

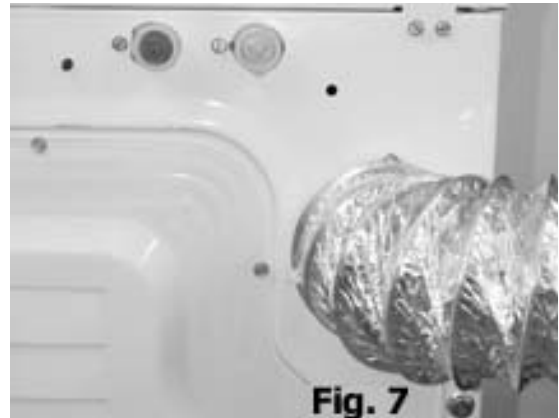

IMPORTANT SAFETY INSTRUCTIONS

WARNING - To reduce the risk of fire, electrical shock, or injury to persons when using your appliance, follow basic precautions, including the following:

- Read all instructions before using the appliance.
- Do not wash or dry articles that have been previously cleaned washed or spotted with gasoline dry cleaning solvents or other flammable or explosive substances as they emit vapors that could ignite or explode.
- Do not allow children to play on or in the appliance. Close supervision of children is necessary.
- Before the appliance is removed from service or discarded remove the door to the washer-dryer compartment.
- Do not reach into the appliance if the drum is moving.
- Do not install or store this appliance where it will be exposed to the weather
- Do not tamper with controls.
- Do not repair or replace any part of the appliance or attempt any servicing unless specifically recommended in the user-maintenance instructions or in published user-repair instructions that you understand and have the skills to carry out.
- Do not add gasoline dry-cleaning solvents or other flammable or explosive substances to the wash water. These substances give off vapors that could ignite or explode.
- Under certain conditions, Hydrogen gas may be produced in a hot water system that has not been used for 2 weeks or more. **HYDROGEN GAS IS EXPLOSIVE.** If the hot water system has not been used for such a period, before using this combination washer-dryer, turn on all hot water faucets and let the water flow from each for several minutes. This will release any accumulated Hydrogen Gas.
- Do not use heat to dry articles containing foam rubber or similar textured rubber-like materials.
- Keep the exhaust opening and surrounding areas free from accumulation of lint, dust, and dirt.
- The interior of the machine should be cleaned periodically by qualified service personnel.
- Do not place items exposed to cooking oil in your dryer. Items contaminated with cooking oils may contribute to a chemical reaction that could cause a load to catch fire.
- Clean dry filter assembly at rear of machine, if applicable, regularly.
- Clean drain filter assembly at front of machine regularly.

Recessed, Closet And Alcove Installation Instructions

The Machine may be installed in a recessed area, closet or alcove.

The installation spacing is in inches and is the minimum acceptable.

Additional spacing should be considered for easy installation, servicing and compliance with local codes and ordinances.

Closet installation must be exhausted.

Other installations must use the minimum dimensions indicated.

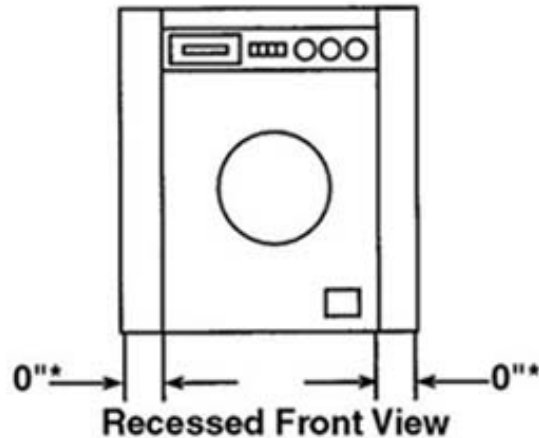

**WARNING - To Reduce The Risk Of Fire
This Appliance
MUST BE EXHAUSTED OUTDOOR.**

Minimum Installation Spacing

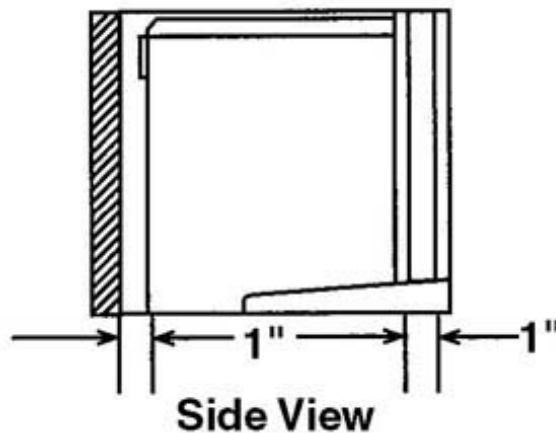

* Additional clearances for wall, door and floor moldings may be required.

** Additional space is needed when an external exhaust elbow is used.

SAVE THESE INSTRUCTIONS

OPERATING INSTRUCTIONS

LAUNDRY PREPARATION

Sorting

Clothes should be sorted to separate items which could damage other garments. Sort items into loads according to similar colors, fabrics, garment construction and degrees of soil.

- Color - Separate clothes into three groups: whites and pastels medium and bright colors and dark colors. Items which bleed color should be washed alone.
- Type of fabrics - Delicate items should be separated from sturdier items. Fabrics that shed lint should be separated from those which shed none or attract lint.
- Garment constructions - Garments that fray easily or that have unusual trim require gentle care. These garments may be washed in the front loader using the knit cycle. If garments are fragile and delicate hand washing may be desirable.
- Degree of soil - Heavily soiled items should be separated from the rest of the wash to prevent transfer of soil in the wash water.

Inspection

While sorting clothes into wash-loads, also inspect each garment to see if it requires special care.

- Remove stains while they are fresh and easy to get out. Try cold water first to remove unknown stains. Hot water sets stains containing protein such as blood, egg, meat and milk. To remove difficult stains, refer to the Stain Removal Chart at the end of this book.
- Pre-treat heavily soiled areas such as collars cuffs and centers of pillow cases. Refer to the "Pre-treating" section for specific instructions.
- Mend rips and tears before washing so further damage is not done to garments.
- Empty pockets. Objects left in pockets such as crayons pens markers or tobacco crumbs may stain an entire wash load. Paper tissues will shred leaving bits on each item in the washer. Remove coins and other foreign objects to prevent damage to the machine.
- Fasten all hooks zippers and buttons.
- Turn knit garments wrong side out to reduce the tendency of knits to "pill". Fabric "pills" are balls of fiber on the surface of the garment caused by wear or friction.
- Remove loose dirt and sand. Brush dirt from trouser cuffs. Shake or vacuum rugs to remove loose surface soil.
- If buckle is washable place a scrap of material securely around the ornament before washing and drying to prevent scratching and damage to the machine. Remove non-wash-able trims, buckles, buttons and belts.
- Tie strings, belts and apron sashes into bows to avoid tangling during washing.

Pre-treating

Pre-treat heavily soiled areas such as collars, cuffs and centers of pillow cases by using a pre-wash spray, or brushing liquid detergent or a laundry detergent and water paste over the areas before washing.

Refer to the **Stain Removal Chart** for treatment of specific stains. If an entire item is heavily soiled or very stained, it may be easier and more effective to pre-wash the item before laundering than to pre-treat every spot.

Pre-Washing

Pre-wash excessively soiled clothes, such as work or children's play clothes.

They often contain deeply embedded dirt. Pre-washing with detergent will help loosen the soil.

Laundry Aids

Detergents are the most popular cleaning agents for home laundry. Using too little detergent results in poor washability, while using too much causes over sudsing and poor rinsing. Detergents not only remove soil, but also hold it in suspension in the wash water to prevent redepositing it on the wash load. The amount to use depends on wash load size, amount of soil, Water hardness and detergent type. ALWAYS measure the amount of detergent. The amount of suds formed is not necessarily an indication of how much to use. Some detergents form a great amount of suds, others only a few.

Use only detergents suitable for front loading washers for best results.

WASHER FEATURES

ON-OFF Button

After the clothes have been loaded and the desired water temperature and cycle selected, pressing the ON-OFF button causes the cycle to begin.

Medium/High Spin Button

When the button is pressed, the spin speed will be reduced from high to low during the regular cycle.

High Heat Half/Heat Button

When this button is pressed, the half heat drying temperature is obtained. Release for maximum heat. Half heat should only be used with delicate fabrics.

Wash Timer

Enables the operator to select the wash program required according to the type of fabric and degree of soiling. Refer to the program chart on page 10.

Water Cycle Selector

Allows operator to select the temperature of the wash/rinse water.

Drying Timer

This control allows you to preset the drying time you want according to your requirements which may be "damp dry", "ready for ironing" or "dry" ready for putting away. The drying time depends largely on the type of material (some fibers absorb more water than others), the dampness of the articles when the drying is started and the amount of laundry. Table napkins, towels, and similar (rather thick) articles will take a longer time to dry. After all the controls have been correctly set, the dryer will start to operate as soon as you close the door. During operation the Drying Timer will gradually return to the "Stop" position "O". The final 12 minutes of the drying cycle is the cooling phase. At the end of this cooling phase it will automatically switch itself off.

Cool Drying Period

Towards the end of the tumble-drying cycle there is a cool drying period which lasts about 12 minutes. The heater is off during this period, while the machine continues to tumble.

When setting a wash/dry cycle the dryer pre-heats the drum during the final spin on all cycles.

The cooling feature helps minimize creasing, and is particularly important with synthetic fabrics. It is also important to cool snaps, zippers, buttons and the machine interior. Practice will soon tell you just how much drying time to allow to get the effect you want.

Drain Screen

The removable drain screen which protects the pump from lint and foreign matter needs to be cleaned periodically. How often will depend on your wash load, e.g. cotton towels cause more lint to collect than nylon loads. Open the service door by pressing on the left hand side. Turn drain screen counter-clockwise and pull the drain screen out. Have a cloth or shallow tray under the drain screen housing, as a small quantity of water may run out. You may find it helpful to first set the machine to spin, allow the unit to start, then remove the drain screen once unit starts. This procedure reduces the amount of water released.

Clean the screen under running water to help remove any lint. Replace the screen by sliding back into the housing within 3 minutes. Lastly turn clockwise to secure.

Under no circumstances should the drain screen be removed while the machine is full of water.

Detergent Dispenser

The detergent dispenser is designed so detergent, additives and bleach will flush automatically into your machine.

Use only 1 to 2 tablespoons of powder detergent or liquid equivalent.

It is divided into 4 compartments, for cold wash, hot wash, detergents, additives (i.e. fabric softeners) and bleach.

At the end of the wash program, any remaining liquids will be automatically siphoned out leaving the dispenser ready for the next wash.

A small amount of water may remain in compartment "C" and/or "D" at the end of the wash program. This can easily be removed by pouring a small additional amount of water into this compartment, which allows the siphon to operate and draw all the water into the machine.

Note: The detergent dispenser drawer and housing should be cleaned to prevent a build up of detergent and fabric softener. This dispenser drawer is easily removed by pulling out. Rinse it under the tap, dry and replace.

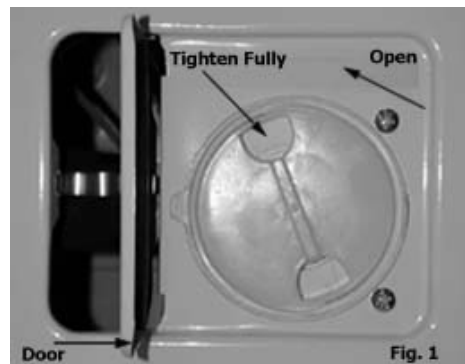

DETERGENT DISPENSER DRAWER

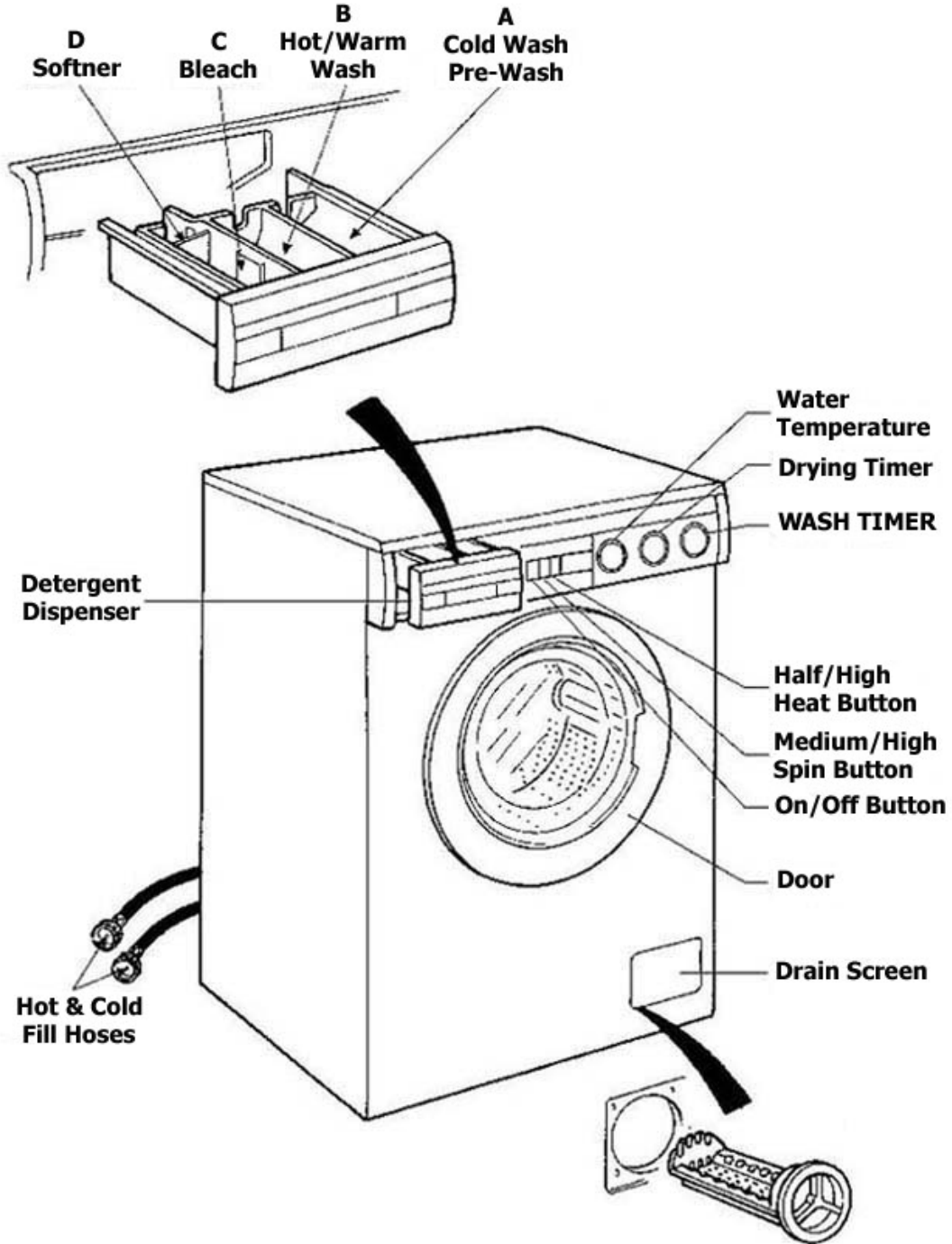

HOW TO WASH

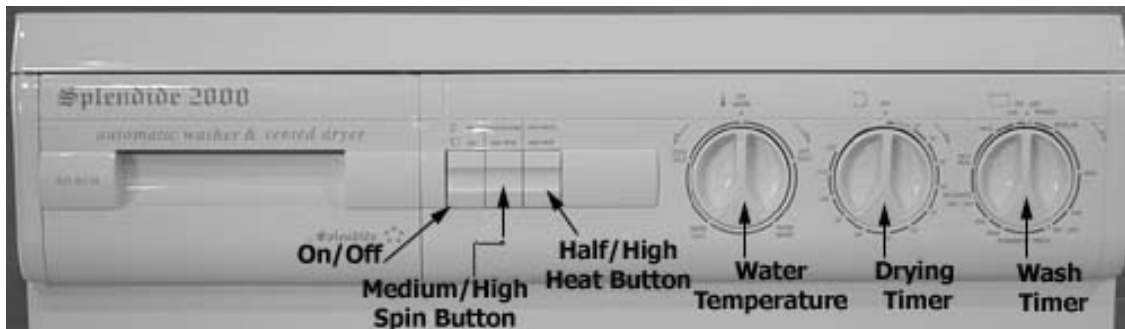

Operating Steps

Before using the washer for the first time, wipe the inside and outside with a damp cloth to remove any travel dust that has accumulated and we recommend operating a rinse

cycle to rinse out your machine.

Be sure the hot and cold water faucets are turned on fully. Make sure that the power cord is plugged in and that the circuit is energized.

To familiarize you with a load of convenience we suggest "**Your First Load**" be typical queen-size bedding. This machine may be set to wash and dry automatically in any cycle. Single-size sets will dry quicker and king-size longer. Different types of materials may benefit from being shaken out once the dry cycle has run long enough (approximately 2 minutes) to allow the door to be opened. It is important the clothes are able to tumble freely to allow the drying process to occur. Dry times of over 100 minutes indicate an over load condition that has resulted in a loss of dry performance.

Your First Load

- Use only 1 to 2 tablespoons of powder detergent or liquid equivalent. For cold/cold wash and rinse add detergent to dispenser "A"; for all other wash cycles, add detergent to dispenser "B". Refer to Wash Table for other additive options.
- Set the wash timer to regular wash. Set the water selector to the desired wash rinse temperatures.
- Set the heat and spin buttons to the out positions.
- Set the dry timer to 80 minutes (This automatically includes a 12 minute cool down).
- Place a set of queen-size sheets and pillow-cases in the drum loosely.
- Push the on button.
- Water will begin to enter the drum and the wash cycle will start. Wash time will be approximately 60 minutes, upon completion, the machine will automatically start to dry the load. When the dryer has completely finished it's cycle the machine will automatically stop.

- After washing and drying are complete the hot and cold water faucets should be turned off and push the ON/OFF switch. Wipe the inside off the washer door and rubber boot with a soft cloth or sponge to remove any remaining moisture.
- Once the machine is started in the wash cycle, for your safety, the door is automatically locked and cannot be opened. Attempting to open the door may break the handle or the latch. If for some reason the door must be opened during the cycle, operate in the following way:
 - Press push button OFF.
 - Turn timer knob to spin position.
 - Press push button ON and wait until water is discharged.
 - Press push button OFF and wait at least 2 minutes for door lock to open.
 - To restart go back to "Operating Steps".

Pre-Wash

On more heavily soiled wash loads a pre-wash will help to obtain a better wash. It will disperse any superficial dirt and help loosen soil ready for the main wash. To pre-wash, select the main wash cycle you wish to use. Then turn the timer knob to the pre-wash setting immediately preceding the regular cycle. If pre-wash with detergent is required, the detergent must also be added in compartment "A" of detergent dispenser. After the pre-wash is completed the machine will automatically perform the regular wash.

NOTE: When you set a combined program of washing and tumble-drying, the cylinder must not be loaded with more than the required load size stated earlier in this manual.

Judge this load by the dry times achieved. Dry times of over 100 minutes indicate an overload condition that has resulted in a loss of dry performance.

HOW TO USE YOUR NEW WASHER-DRYER

- Load the drum with clothes as previously described. Close the door.
- Select a program. See chart below.
- Select drying time (and half heat if required).
- Select desired spin speed (high spin only occurs in regular wash cycle).
- Put the detergent, bleach and fabric conditioner into the dispenser.
- Press the ON-OFF button to start the machine.

Note: Woolen garments should under no circumstances be tumble dried.

TUMBLE-DRY

If you want to tumble dry a load without washing, rinsing or spinning, proceed as follows:

Note: The dry weight of the load must not exceed requirements previously mentioned.

- Make sure that the power cord is plugged in and that circuit is energized.
- Make sure that the wash timer knob is at an OFF-DRY position.
- Press the Half Heat button, if you wish to dry at a low temperature.
- Set the Dryer Timer knob to the drying time you require.

- Open the door, load the articles to be dried into the cylinder and close the door.
- Press the ON/OFF button in and the machine will then start the drying cycle.
- Door may be opened during drying cycle.

TO RINSE, SPIN AND TUMBLE-DRY

It is possible to rinse, spin and tumble-dry articles which have not been previously washed in the machine. The dry weight of the load must not exceed load size previously described.

- Make sure that the power cord is plugged in and that the circuit is energized.
- Open the hot and cold water taps fully.
- Load the machine with the articles to be rinsed.
- If you wish, put fabric conditioner in the additives compartment "D" of the Detergent Dispenser.
- Turn the program selector knob to the position marked "Rinse". Select the desired heat setting. Press the half heat if you want a low dry temperature. Set the dryer timer to the desired time.
- Select the desired spin speed. High speed spin only occurs in the regular cycle.
- Switch the machine on by pressing the ON/OFF button.

WASHING TABLE

TYPE OF FABRIC	TIMER CYCLE	TEMP WASH RINSE	SPEED AGITATE		DISPENSER**			
					A	B	C	D
Cotton & Linens	Regular	H/W	N	1000 rpm	X	X	X	X
Sturdy		H/C			X	X	X	X
White		W/W			X	X	X	X
Non Colorfast		C/C			X*			X
All Cold								
Permanent Press	Perma Press	H/C	N	800 rpm		X	X	X
Sturdy		W/C			X*	X	X	X
Delicate		C/C						X
All Cold								
Knits & Delicates	Delicate	W/C	S	400 rpm		X		X
Delicate		C/C			X*			
All Cold		W/C				X		X
Wool								

**Compartments may be used with the selections indicated.

*With the cycle C/C please proceed as follows.

COLD WASH

Add detergent in compartment "A"

PRE-WASH/COLD WASH

Add detergent in compartment "A" and Switch the machine on.

When the machine starts the pre-wash, open the detergent dispenser drawer and add further detergent to compartment "A" for the REGULAR wash cycle.

LAUNDRY AIDS

Detergent Amount Recommendations

- Use only a low sudsing detergent, one or two tablespoons (maximum) of the standard powder detergent or liquid equivalent.
- The degree of soil will change detergents amounts. For heavier soiled loads, increase the amount of detergent used, for lightly soiled loads decrease the amount of detergent used.
- If water is extremely hard, detergent should be increased. Reduced detergent amounts should be used in soft water (under 3.5 grains per gallon).
- If garments have been pre-treated, decrease the amount of detergent. If garments have been heavily pre-treated, it may not be necessary to add detergent.
- If the previous machine owned was a top loader, the initial wash loads in a front loader may require a reduced amount of detergent until the detergent remaining in the clothes is removed. Old detergent trapped in the garments will be released during the tumble action wash cycle.

Detergent will be flushed automatically into the machine from the detergent dispenser. The suds level should never rise more than halfway up the porthole. Too much foam will not only impede the wash action of your machine but will rinse through the detergent dispenser and make a mess on the floor!

If this should happen clear excessive suds by setting the timer to the beginning of the first rinse and allow the machine to rinse out.

Bleach

Bleach functions to whiten clothes, remove certain problem stains, to deodorize and in some cases to sanitize; however bleaching is not a substitute for good laundry techniques. Bleach only during the wash cycle. Bleach should never be added to the rinse water. Always dilute bleach before using.

To add bleach, open detergent dispenser door and pour it in required compartment front left.

WARNING: Under no circumstances overfill the bleach dispenser. Excessive bleach will run directly into the machine, and may damage the clothes.

Liquid Fabrics Softeners

All fabrics, particularly towels and diapers, benefit from the use of fabric conditioners in the final rinse. Items of laundry feel softer, are more easily ironed and the clinging affect of synthetics is considerably reduced.

We recommend using a bio-friendly softener or other softeners that appear light or white in color and have a more liquid consistency. These type products are found to dissolve more thoroughly in less water in this type machine.

Add one to two tablespoons of softener to the "Additives" compartment "D" of the detergent dispenser. Under no circumstances overfill, as the softener will immediately siphon into the machine and in so doing impair the wash results.

STAIN REMOVAL CHART

Blood

Rinse or soak fresh stain in cold water. Work detergent into any remaining stain. Rinse. If stain persists, put a few drops of ammonia on stain and repeat detergent treatment. Rinse. If necessary bleach.

Candle Wax

Scrape off excess. Place stain between clean white blotters or several layers of facial tissues. Press with warm iron. Sponge with cleaning fluid. If dye spot remains, bleach.

Chewing Gum

Rub with ice to harden. Scrape off excess with dull blade. Sponge with cleaning fluid.

Chocolate or Cocoa

Soak 15 minutes in cold water. Rub detergent paste into stain, then rinse thoroughly. Launder in hottest water safe for fabric. If colored stain remains, sponge with hydrogen peroxide, rinse and launder.

Cod Liver Oil

Sponge article with cleaning fluid. Soak in warm suds. If stain persists, wash with bleach safe for fabric.

To remove yellow stain, sponge with hydrogen peroxide. Rinse and launder. Old stains may be nearly impossible to remove.

Coffee or Tea (Black)

Soak fresh stains immediately in cold water. Then use bleach treatment with hottest water safe for fabric. Or if safe for the fabric pour boiling water through spot from a height of 1 to 3 feet. Launder.

Coffee or Tea (With Cream)

Rinse or soak in cold water. Work detergent into stain. Rinse. Dry. If grease stain remains, sponge with cleaning fluid. Repeat, if necessary. If stain remains, bleach.

Cosmetics: Eye Shadow, Lipstick, Liquid Make-Up, Mascara, Powder, Pancake Make-Up or Rouge

Apply undiluted liquid detergent to stain, or dampen stain and rub in soap or detergent paste until thick suds are formed. Work in until stain is gone, rinse well. Repeat if necessary. If color remains, bleach is safe for fabrics.

Cream, Ice Cream or Milk

Sponge stain with cool water or soak stain in cool water for 30 minutes or longer. If stain remains, work a detergent into spot then rinse. Bleach if necessary.

Deodorants and Antiperspirant

Wash or sponge stain thoroughly with warm water and detergent; rinse. If stain remains, bleach with hot sudsy water. Launder. You may be able to restore fabric color by sponging with ammonia. Rinse thoroughly.

Dye

Rinse or soak in cold water. Work detergent into stain. Rinse. If necessary, bleach. Stain is not always possible to remove. A commercial color remover may also be used.

Egg or Meat Juice

Rinse in cold water. If stain remains, sprinkle with meat tenderizer - let stand 15 to 20 minutes. If stain still remains, sponge with cleaning fluid or diluted bleach. Launder in hot water. The use of hot water first may set stain.

Fabric Softener Stain

Rub with bar soap until stain has lightened. Rinse thoroughly. Launder. Rubbing alcohol is sometimes effective if the color of the garment can take it. Launder. If desired, dry cleaning can be used.

Felt Tip Pen

Spray spot with cleaners suitable to this purpose. Sponge stain thoroughly. Rinse with cold water. Reapply cleaner if necessary.

Fruit, Wine

Soak fresh stains immediately with cool water. Then use bleach treatment with hottest water safe for fabrics, pour boiling water through spot from a height of 1 to 3 feet. Launder.

Grass

Work detergent into stain. Sponge with denatured alcohol. Bleach, if necessary.

Grease or Oil

Scrape away excess. Rub detergent paste or a general purpose liquid house hold cleaner into stain, rinse with hot water. If stain remains, sponge thoroughly with a grease solvent. Dry. Repeat if necessary. To remove Yellow stain, use a chlorine or oxygen bleach.

Ink, Ball-Point

Some ball-point inks are set by water. First test a scrap of cloth. Sponge stain repeatedly with acetone, amyl acetate or rubbing alcohol. Hair spray is effective. Launder. Bleach if necessary. Use amyl acetate on triacetate, arnel, dynel and verel. Use acetone on other fabrics.

NOTE: Some inks cannot be removed.

Ketchup

Scrape of excess. Soak in cold water 30 minutes. Pre-treat with a detergent paste. Launder.

Mildew

Brush off surface growth to keep mold spores from spreading. Dip article into solution of ½ cup bleach per 1 gallon of cool sudsy water for 5 to 10 minutes. Rinse well. Launder.

Mud

Let stain dry; then brush well. Rinse repeatedly in cool water until mud comes out. Launder.

Note: Hot soap suds set a red or yellow clay stain.

Mustard

Soak in hot detergent water for several hours. If stain remains, bleach.

Nail Polish

Treat while fresh, scraping or wiping off as much as possible, before it dries. Place stain face down on white paper towels. Sponge back of stain acetone (nail polish remover) or sponge with denatured alcohol and a few drops of household ammonia. Sponge stain frequently. Launder with water at temperature suitable for fabric. Note: Do not use acetone on acetate, arnel, dynel or rayon.

Paint

Sponge or soak in turpentine or solvent recommended as a thinner on label. Launder.

Perfume

Rinse in cold water. Rub undiluted liquid detergent or a detergent paste into stain. Rinse. If stain remains, bleach.

Perspiration

Wash or sponge stain thoroughly with warm water and detergent paste. If perspiration has changed the color of the fabric, restore it by treating with ammonia or vinegar. Apply ammonia to fresh stains; rinse with water. Apply vinegar to old stains; rinse with water.

Rust and Iron

Apply commercial rust remover, according to manufacturer's directions. Rinse. Or, if safe for fabric, boil stained article in solution of 4 teaspoons of cream of tartar to 1 pint water.

Scorch

Rinse or soak in cold water. Work detergent into stain. Rinse. Bleach, if necessary. Stain may be impossible to remove.

Shoe Polish

Scrape off as much as possible. Pre-treat with a detergent paste; rinse. If stain persists, sponge with rubbing alcohol (1 part to 2 parts water) or turpentine. Remove turpentine by sponging again with warm detergent solution or with alcohol. Bleach if necessary.

Soft Drinks

Sponge with cold water, some stains are invisible when they have dried, but turn brown when heated and may be impossible to remove.

Tar and Asphalt

Act quickly before stain is dry. Sponge with grease solvent or turpentine. Launder.

Urine

Soak in cool water. If stain is dry, work a detergent paste into the spot then rinse. If necessary, bleach.

CARE AND CLEANING

Cleaning The Exterior

As you use the washer, occasionally wipe the cabinet with a damp cloth or sponge; wipe dry with a soft cloth. Do not use polish or any kind on the plastic trim. Some polishes contain agents which may damage plastics.

Cleaning The Interior

If you live in an area where phosphate detergents are banned, it may be necessary to recondition the washer periodically. Because a non-phosphate detergent must be used, body oils and detergent may accumulate in the washer tub. This is particularly evident in hard water areas or in homes, where heavily soiled garments are regularly laundered.

To remove this build-up, run the washer through a complete cycle using hot water and 2 cups of a non-precipitating water conditioner. Do not add any clothes, laundry detergent or other laundry aids.

Once all accumulation has been removed, your laundry should be satisfactory if you follow the preventive suggestions in this guide-book.

General Maintenance

After washing is complete, the water faucets should be turned off to relieve water pressure on the hoses. Wipe the inside of the washer door with a soft cloth to remove any remaining moisture. Periodically, a thin coat of paste wax should be applied to the inner door of the washer; especially to the area which is immediately next to the door window.

This will protect the door finish from laundry aid spills and any discoloration which may result from these spills.

The interior of the machine should be cleaned periodically by qualified service personnel.

Cleaning The Drain Screen

Clean the drain screen frequently. For instruction please refer to page 7 of this manual.

WINTERIZING

- Turn off the hot and cold water source to machine.
- Set machine to fill in regular cycle on warm wash.
- Turn machine on for a few minutes so machine can take on any water.
- Lift inlet hoses to assure no water is left in inlet hoses.
- Turn unit off.
- Advance the wash timer to spin cycle and turn on. This will activate the water pump and will evacuate as much water as possible.
- Turn unit to off.
- Place a towel under the drain filter area and remove drain filter. This will drain any water left in the bottom of unit.
- Install drain filter correctly to assure it does not leak water.
- In extreme conditions you may wish to completely remove the inlet hoses.
- Complete

AVOID-SERVICE CHECK LIST

You may save the cost and inconvenience of an unnecessary service call by first reviewing this easy-to-use check list of the most frequently encountered situations that are not the result of defective workmanship or materials.

You will be charged for a service call while the appliance is in warranty if the problem is not caused by defective workmanship or materials.

Review this **Avoid-Service Check List** before calling for service. It may save time and expense.

Washer Does Not Start

- Washer may not be plugged in or connection may be loose.
- House fuse blown or circuit breaker tripped.
- Timer knob not in correct position.
- Cycle selector knob not in correct position.
- Door is not securely shut.

Washer Stops During Cycle

- Drain hose is kinked or clogged (Fig. 1).
- House fuse blown, circuit breaker tripped, or wall plug not firmly in receptacle.
- No more than 6" of the drain hose should insert into a standpipe.
- The outlet end of the drain hose must be at least 20" (50 cm) above the base of the machine.

- Assure an air break is available to prevent the machine from siphoning in a standpipe.
- The standpipe should be at 25" (62 cm) minimum 34" (86 cm) maximum height.
- Assure the drain loop or suitable clamp to support drain hose has been used.

Water Does Not Enter The Washer, Or It Enters Slowly

- Water supply is not adequate in the area.
- Hot and cold water faucets for the inlet hoses are not turned completely on.
- Water is being used elsewhere in the house, when the washer is running.
- Water inlet hose filter are clogged (Fig. 3).
- Water inlet hoses are kinked.

Wash And Rinse Water Temperatures Are Incorrect

- The hot water hose and cold water hose are connected to the wrong faucets.

Water Is Entering Washer But Tub Does Not Fill

- Standpipe for the drain hose is not the correct height. (Fig. 2), drain hose is too far into standpipe or air break does not exist.

Water Leaks

- Hose connections at faucet and/or machine not tight.
- Rubber washers are not inside the metal hose connectors (Fig. 3).
- Drain hose not securely fastened (Fig. 1,2). Drain pipes in the house are clogged.
- Too much detergent or a high sudsing detergent in soft water is being used.
- Soil may be on the door seal or gasket of the washer preventing a tight seal.

Water In Washer Does Not Drain Or Drains Slowly

- Drain hose is kinked or clogged (Fig. 1).
- Standpipe does not have a large enough diameter and is slowing the draining process.
- Machine is over soaped.
- Wash filter plugged.

Over Sudsing

- Too much detergent used.
- Detergent used is not compatible with water conditions.
- Garments were pretreated, before washing.
- Additional laundry aids such as oxygen bleach may cause additional sudsing.

"Chugging" Noise"

- A certain amount of "chugging" noise is normal in a heavy-duty machine.

Rattling And Clanking Noise

- Foreign objects such as coins or safety pins may be in the tub.
- Foreign objects may be in the pump.
- Belt buckles and metal fasteners are hitting the washer tub during the washing cycle.

Vibrating Noise

- Washer is not level and lock nuts may not be securely tightened on front adjusting feet.
- A rubber cap may be missing from one of the leveling legs.
- Washer may not be installed on a solid, firm floor.
- The four shipping brackets are still on the machine.

Thumping Noise

- Heavy wash loads may produce a thumping noise at the beginning of the spin cycle.

