



Splendide

Washer-Dryer

Installation Instructions and Use & Care Guide

Lave-linge séchant

Mode d'installation et d'emploi

Lavasecadora

Instrucciones para la instalación y el uso

Quick Reference Guide

WDC6200CEE



Comb-o-matic 6200
EnergyMizer™

Technical Data	2
Installation Instructions	
Installation Requirements	3
Installation/Removal	4
Introduction	6
Getting Started	
About Your Washer-Dryer	7
Understanding the Control Panel	8
Guide to the Wash Programs	9
Preparing Laundry / About Laundry Aids	10
Fabric Care Labels / Stain Removal Chart	11
Operation Instructions	
Choosing a Load	12
About the Dispenser Drawer	13
How to Wash	14
How to Dry	15
Easy Care and Maintenance	
Regular Maintenance.	16
Monthly/Yearly Maintenance	17
Troubleshooting	
Avoid Service Checklist	18
If You Need Service.	19



**DO NOT DISCARD!
THIS INFORMATION
SUPERSEDES THE
INFORMATION FOUND IN
YOUR OWNERS MANUAL**

**KEEP THIS PAGE WITH YOUR
OWNERS MANUAL FOR
FUTURE REFERENCE**

Splendide
WASHER-DRYER

Front-Loading Washer-Dryer

Addendum to Owners Manual

MODELS

WD2000S (Splendide 2000S)
WD2100 (Splendide 2100)
WDC6200 CEE (Comb-o-matic 6200)
WDC5200 (Comb-o-matic 5200)

QUESTIONS?

Splendide Service HQ:

Westland Sales
15650 SE 102nd Ave. (PO BOX 427)
Clackamas, OR 97015

Telephone: Toll Free: 800-356-0766
(Local: 503-655-2563)

Service Fax: (503) 722-9202

E-mail: service@splendide.com

Website: www.splendide.com

DOOR LOCK SUPPLEMENT

Follow these steps if you need to open the door to your washer-dryer after a cycle has already begun

To Open the Door During a Wash Cycle:

1. Advance the Program Selector to 'Reset' and wait 5 seconds.
2. Advance the Program Selector to 'Drain' (8 o'clock) and allow the machine to drain completely.
3. Advance the Program Selector to 'Reset' (The 'Status/Door Lock' LED will blink quickly to indicate that the cycle has stopped, but the door is STILL LOCKED)
4. When the 'Status/Door Lock' LED blinks SLOWLY (takes 1-2 minutes), you can open the door

To Open the Door During a Dry Cycle:

1. Advance the Program Selector to 'Reset' (The 'Status/Door Lock' LED will blink quickly to indicate the cycle has stopped, but the door is STILL LOCKED)
2. When the 'Status/Door Lock' LED blinks SLOWLY (takes 1-2 minutes), you can open the door



IMPORTANT



Once a wash or dry cycle is underway, the washer-dryer door will LOCK for the duration of the cycle and will STAY LOCKED for up to 2 minutes after the cycle ends. DO NOT attempt to open the door unless the 'STATUS/DOOR LOCK' LED is BLINKING SLOWLY!

WINTERIZATION SUPPLEMENT

Follow these steps if you need to winterized your washer-dryer that's installed in a boat or RV

To winterize your washer-dryer:

1. With the machine power OFF, pour ½ quart of RV-type antifreeze into the washer drum
2. Close the door. Advance the Program Selector knob to a SPIN position
3. Press ON/OFF Button (IN). Wait 1-2 minutes
4. Press ON/OFF Button (OUT). Unplug the washer-dryer from the electrical outlet (or disconnect power)
5. Turn the water supply faucets OFF. Disconnect the inlet hoses from the faucets. Drain any remaining water from the hoses. *Finished!*

Optional RV Winterization - If you're currently pumping antifreeze through the fresh water system, follow these steps to winterize:

1. With the machine power OFF, turn the WASH TEMP knob to HOT
2. Advance the Program Selector knob to REGULAR in Cotton Heavy Duty
3. Press the ON/OFF button (IN) and let the machine fill until antifreeze is in the drum
4. Advance Program Selector to a RESET. Wait 5 seconds (Status/Door Lock LED will blink)
5. Advance Program Selector to a SPIN position. Let the antifreeze drain from the drum
6. Advance Program Selector to RESET. Wait 5 seconds (Status/Door Lock LED will blink)

7. Turn the WASH TEMP knob to COLD
8. Advance the Program Selector knob to REGULAR in Cotton Heavy Duty
9. Let the machine fill until you see antifreeze in the drum
10. Advance the Program Selector knob to RESET. Wait 5 seconds (Status/Door Lock LED will blink)
11. Advance the Program Selector knob to SPIN. Let the antifreeze drain from the drum
12. Press the ON/OFF button (OUT). *Finished!*

To use again, flush the water pipes, then:

1. Reconnect the water inlet hoses to the corresponding HOT/COLD faucets. Turn the faucets ON. (NOTE: Check the water inlet hoses and pump periodically. Refer to the "Use & Care Guide" that came with the machine)
2. Plug the washer-dryer into an appropriate electrical outlet (or reconnect power supply)
3. With the ON/OFF button in the off (OUT) position, pour 1/2 TBSP. of powder detergent (or liquid equiv.) into the 'Detergent' compartment inside the Dispenser Drawer
4. Advance the Program Selector knob to an EXPRESS cycle
5. Press the ON/OFF button (IN) and allow the machine to run through the complete cycle to clean out any remaining antifreeze. *Finished!*

Technical Data

Technical Data

Models	Comb-o-matic 6200 by Splendide (WDC6200CEE)
Dimensions	Width: 23.4" (59.5 cm) Height: 33.25"-33.75" (84.5-85.7 cm) Depth: 22.9" (58.1 cm)
Capacity	Drum Size: 1.92 CF Washing: 2-12 lbs. Drying: 2- 8 lbs.
Electrical Conn.	Voltage: 120 Volts, 13 Amp, 60 Hz Max. Absorbed Power: 1300 Watts
Water Conn.	Max. Pressure: .69 MPa (6.9 bar), 100 PSI Min. Pressure: 0.05 MPa (0.5 bar), 7.5 PSI
Spin Speed	Up to 1200 RPM

NOTE: The manufacturer reserves the right to make any improvements to its appliances without giving prior notice.

■ Minimum Installation Spacing

This appliance may be installed in a recessed area, closet or alcove. The installation spacing is in inches and is the minimum acceptable. Additional spacing should be considered for easy installation, servicing and compliance with local codes and ordinances. Installations must conform with the minimum dimensions indicated.

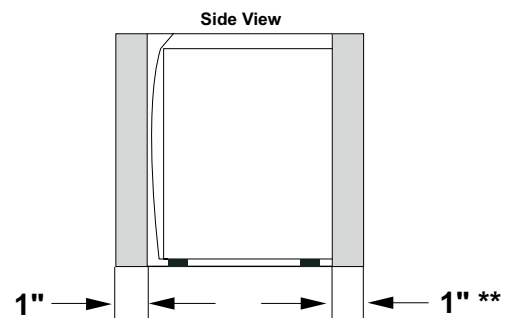
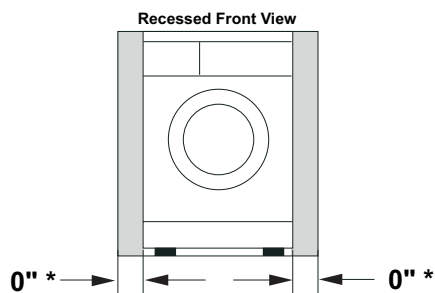

* Additional clearances for wall, door/floor moldings may be required.



As an Energy Star Partner, Splendide Division Westland Sales has determined that Energy Star labeled models meet the Energy Star guidelines for energy efficiency.



This appliance was tested by UL and conforms with both Canadian and U.S. UL safety requirements and displays their mark.

Installation Instructions

Installation Requirements

GROUNDING INSTRUCTIONS

This appliance must be grounded. In the event of malfunction, or breakdown, grounding will reduce the risk of electric shock by providing a path of least resistance for electric current. This appliance is equipped with a cord having an equipment grounding conductor and grounding plug. The plug must be plugged into an appropriate outlet that is properly installed and grounded in accordance with all local codes and ordinances. DO NOT modify the plug provided with the appliance. If it will not fit the outlet, have a proper outlet installed by a qualified electrician.



WARNING: Improper connection of the equipment-grounding conductor can result in a risk of electric shock. Check with a qualified electrician or serviceman if you are in doubt as to whether the appliance is properly grounded.



Attention!



For your own protection and to prevent accidents, injury, and fire, please read the following carefully before installing the washer-dryer.

- Installation and grounding must be done in accordance with local codes and by a qualified installer. Installation Instructions provided in this booklet are for the installers' reference.
- Washer-dryer **MUST** be installed on a strong, level floor and in a protected dry and well-ventilated area close to a power supply and drain outlet of sufficient capacity. DO NOT install on carpet.



IMPORTANT: Installation on carpet floors will cause the machine to vibrate and may result in excessive machine vibration during the spin cycles and loss of performance.

- The washer-dryer should be plugged into a properly grounded (3) prong electrical outlet capable of 120 Volt, 60 Hz, 1300 W, and 13 Amp. It shouldn't be controlled by a wall switch or pull cord which could be turned off accidentally. For your safety, the third or round grounding prong must never be removed. DO NOT USE AN EXTENSION CORD.
- DO NOT install or store this appliance where it will be exposed to weather or in an area where gasoline or other flammables are stored.

■ Electrical

- **Machine Voltage/Amperage** - 120V, 60 Hz, 1300 W, 13 Amp.
- **Connection** - 3-prong plug with 6' cord is provided with the machine.
- **Circuit/Protector** - 3-wire single phase, 120V, 60 Hz, AC, on a separate 15 Amp circuit.

■ Location

This machine may be installed free standing as well as in a recessed area, closet, or alcove.

- **Minimum Installation Spacing** - 0" on sides and 1" in front and back. *NOTE: Additional installation spacing needs to be considered for easy installation, servicing, and compliance with state and federal codes.*
- **Floor** - Must support at least 280 lbs. and be a solid, level surface. DO NOT install on carpet.
- **RV/Marine Applications** - When locating the appliance in a towable trailer or watercraft, position the machine over the axles or mid-ship where movement is at a minimum. Block the machine to prevent extreme movement.
- **No Dryer Vent Requirements For This Machine** - This machine uses an internal condenser for drying. All humidity stays within the unit and is drained as water. No heated or conditioned air is exhausted outside; no exhaust vent is needed.

■ Drainage

- **Standpipe Diameter/Capacity** - Needs a 1 ¼" minimum diameter standpipe with a minimum carry-away capacity of 7 gallons per minute.
- **Top of Standpipe** - Must be between 25" - 34" high from the bottom of the machine.
- **Outlet End of Drain Hose (provided with the unit)** - Must be at least 20" above the bottom of the washer-dryer. An air break must be available at the standpipe to avoid siphoning. No more than 6" of the drain hose should be inserted into the drain pipe to prevent siphoning.

■ Splendide Accessories (Available Separately)

- **Faucet Adapter Kit** allows for a direct faucet connection.
- **Optional Drain-A-Way Pans** designed to be drain plumbed.

WARNING: Splendide denies all liability if these instructions are not followed correctly.

Installation Instructions

Installation / Removal

■ 1. Unpacking Your Washer-Dryer

- Carefully remove the packing materials with care not to damage the drain hose and power cord that are shipped installed on the machine. Check that the machine is intact. Report any damage immediately.
- Position the washer-dryer near the desired installation position.



WARNING: Plastic bags, Styrofoam, nails and other packaging parts are not children's toys and can be potentially dangerous. Destroy the carton and plastic bags after the washer-dryer has been unpacked.

■ 2. Remove the Transit Screws/Spacers

- For transportation, the inside of the machine is supported by screws, rubber grommets and spacers on the back panel. Before using the washer-dryer, these items **MUST** be removed.



IMPORTANT: Transit screws and spacers must be removed before operating the machine to allow proper operation of the machine and to prevent damage to the appliance.

- After positioning the washer-dryer near the installation location, remove the four screws (Fig. 1), with the rubber grommets and plastic spacers that are attached to them.
- Use the plastic plugs (provided in the accessories bag) to fill in the holes.

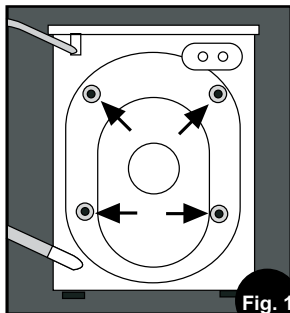

IMPORTANT: Retain the transit screws, spacers and rubber tubes. These items should be reinstalled to prevent damage if or when you transport the machine in the future.

■ 3. Connecting Water Inlet

- If the water pipes you will be connecting to are new or unused, run the water until clear to remove any debris that could clog the water valve screens or valves before connecting the machine. **NOTE:** Supply shut-off valves should be easily accessible.



IMPORTANT: Water pressure **MUST** range within the values indicated on the "Technical Data" chart (p. 1).

- Included in the accessories supplied with your machine are 2 inlet hoses with 4 rubber washers preinstalled. Check that the rubber washers are installed in the ends of the inlet hoses to make a water tight seal at each connection point.
- Connect the straight ends of the water inlet hoses to the supply taps that have 3/4" BSP thread (standard hose bib).
- Connect the 90° angled ends (20 mm thread) of these hoses to the inlet valves on the back of the machine (Fig. 2). **NOTE:** Water Inlet valves are color coded: Red (Hot) & White (Cold).

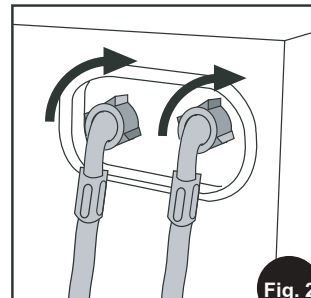

IMPORTANT: Do not use excessive force. Damage to the couplings can result. The couplings should be tightened by hand; a tool should only be used if a leak occurs.

Optional Single Faucet Hook-Up

It is possible to run the machine on cold water only, but a water supply must be connected to each inlet valve. To do this, we suggest you use a "Y" connector (contact Splendide). Connect the "Y" connector to a tap. After checking that the 4 rubber washers (provided) are installed in the ends of the inlet hoses, connect the straight ends of the hoses to the "Y" connector (Fig. 3). Then connect the

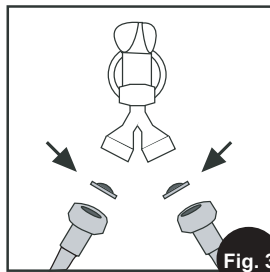

90° angled ends of these hoses to the inlet valves on the back of the machine (Fig. 2). **NOTE:** When the machine is connected to a single faucet, the water temp. for the wash/rinse settings is regulated by the temperature YOU set at the faucet. If hot or warm water is used for washing, it is important to turn the faucet to COLD after the wash cycle. Cold water is essential to your machines' condensation drying process.

■ 4. Water Drainage

- It is possible for the water to be discharged into a sink, standpipe or drainpipe, but an air break must be available at a min. 20" height to prevent the machine from siphoning (Fig. 6).
- Standpipe Drain System** - Installations require a minimum 1 1/4" (3.2 cm) diameter standpipe with a minimum carry away capacity of 7 gallons (26 liters) per minute.
- Wall or Floor Standpipe Drain System** - The top of the standpipe must be between 25" (62 cm) - 34" (86 cm) from the bottom of the washer (Fig. 4).

Continued on next page

WARNING: Splendide denies all liability if these instructions are not followed correctly.

Installation Instructions

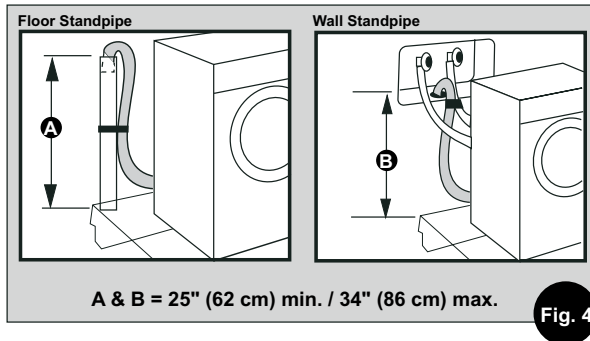

Sink Drainpipe System - Entry into the sink drain system must be above the trap (Fig. 5). When routing the drain hose through cabinets or walls, use a protective material such as electrical or duct tape to cover sharp edges that could damage the drain hose. Use a suitable clamp to secure the drain hose to the “Y” branch or the disposer. With a sink drainpipe system, you may connect directly: 1) to a disposer by following the manufacturer's attachment method. 2) directly to a “Y” branch tail piece (available at most hardware stores). 3) Through the floor to a separate trap. The trap must be vented to prevent siphoning. To provide proper venting, install an Air Gap Kit (available at most hardware stores). 4) To the faucet using a Faucet Adapter Kit (available separately). It will supply water from your faucet and discharge water directly into your sink drain.

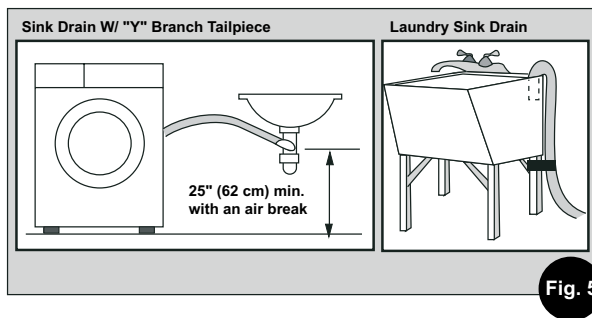

IMPORTANT: Make sure that the drain hose is not kinked and that water flow is not restricted.

- Use a U-Clamp (provided in your accessories packet) or suitable item to secure the outlet end of the drain hose (pre-installed on the back of your machine).
- Insert the outlet end of the drain hose into the standpipe, wall or floor drain (Fig. 6). *NOTE: The outlet end of the drain hose MUST be at least 20" (50 cm) above the base of the machine. No more than 6" of the drain hose should be inserted into the drain pipe to prevent siphoning.*
- Use a strap, cable tie, or similar item to hold the hose or the U-Clamp in place.

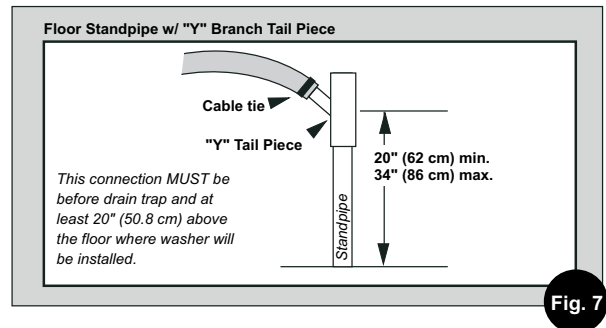
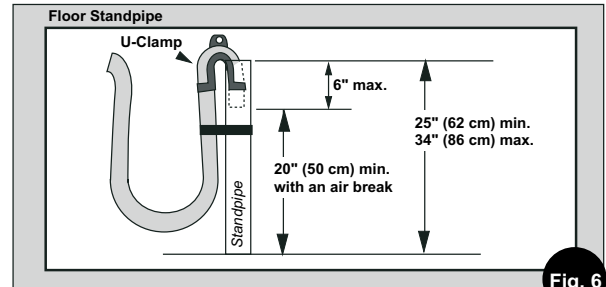

■5. Leveling

- To access the front leveling legs, tilt the machine backwards, leaning it against a wall or other stable structure.
- Adjust the legs up or down (Fig. 8) to ensure the washer is resting solid and does not rock side-to-side or front-to-back when the machine is upright.
- Check that the angle of inclination, measured according to the worktop, does not exceed 2°.

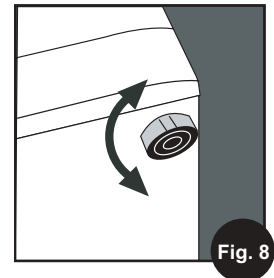

IMPORTANT: The machine must rest solid on a sturdy floor for optimum performance and minimum vibration.

■6. Electrical Connection

- Plug the power cord into a grounded outlet. See “Grounding Instructions” (p. 2) for complete details. *NOTE: Check to ensure the power is OFF at a circuit breaker/fuse box before plugging the power cord into the outlet.* Turn power on at the circuit breaker/fuse box.

■7. Before Using Your Washer-Dryer

- Read manual thoroughly. Keep these instructions for future reference.
- Run the empty washer-dryer through a complete wash cycle to check for water leaks and proper operation.
- Wipe the inside and outside of the appliance with a damp cloth to remove any dust that has accumulated during transit.

WARNING: Splendide denies all liability if these instructions are not followed correctly.

Congratulations!

Thank you for choosing Splendide - North America's #1 selling combination laundry center since 1984. Your new Splendide washer-dryer is designed to give you maximum washing and drying performance while using less energy/resources and taking up less space. The performance levels, safety features, sturdiness and all its functions are the result of ongoing technological innovation. The ultimate purpose? To offer you the best performance with the utmost simplicity.

■ Read This Manual

Inside this book you will find many helpful hints on how to install, use and maintain your new washer-dryer properly. Please read this manual carefully. Just a little preventative care on your part can save you a great deal of time and money over the life of your washer-dryer. If you need further assistance, please contact Splendide Laundry Centers at 1-800-356-0766.



■ For Your Records

Write model and serial numbers here. You can find them on the front of the machine and inside of the door opening.

Model #: _____

Serial #: _____

CAUTION
RISK OF ELECTRIC SHOCK
DO NOT OPEN

CAUTION: To reduce the risk of electric shock, DO NOT remove cover (or back)/No user serviceable parts inside. Refer servicing to qualified services personnel.

 The lightning flash with arrowhead symbol, with-in an equilateral triangle, is intended to alert the user to the presence of uninsulated "dangerous voltage" within the product's enclosure that may be of sufficient magnitude to constitute a risk of electric shock to persons.

 The exclamation point within an equilateral triangle is intended to alert the user to the presence of important operating and maintenance (servicing) instructions in the literature accompanying the appliance.

Save these instructions For Your Safety

Your washer-dryer has been built in compliance with the strictest international safety regulations. However, for your safety, the information in this manual must be followed to minimize the risk of fire or explosion, electric shock, or to prevent property damage, personal injury, or loss of life.

- Read all instructions before using any appliance.
- Do not wash or dry articles that have been previously cleaned in, washed in, or spotted in gasoline, dry cleaning solvents, other flammable/explosive substances as they emit vapors that could ignite or explode.
- Before the appliance is removed from service or discarded, remove the door to the washing/drying compartment.
- Do not repair or replace any part of the appliance or attempt any servicing unless specifically recommended in the user-maintenance instructions or in published user-repair instructions that you understand and have the skills to carry out.
- Do not allow children to play on or in the appliance.
- Do not add gasoline, dry cleaning solvents, items contaminated with cooking oil or other flammable or explosive substances to the wash water. These substances give off vapors that could ignite or explode.
- Do not place flammable substances around your washer-dryer during operation.
- Under certain conditions, Hydrogen gas may be produced in a hot water system that has not been used for 2 weeks or more. HYDROGEN GAS IS EXPLOSIVE. If the hot water system has not been used for such a period, before using the appliance, turn on all hot water faucets and let the water flow from each for several min. This will release any accumulated hydrogen.
- Do not use heat to dry articles containing foam rubber or similar textured rubber-like materials.
- Turn off water faucets to relieve pressure on hoses and valves and to minimize leakage if a break or rupture occurs.
- Do not reach into the appliance if the drum is moving.
- Do not tamper with controls.
- Repair or replacement of a part should be made only by a qualified service technician to prevent personal injury or damage to the machine. Contact Splendide to locate an authorized repair service company near you.
- Qualified service personnel should clean the interior of the machine periodically.
- Disconnect power to the washer at the circuit breaker or fuse box, or unplug the machine in an emergency or when servicing is required. Have the installer show you and label the proper switch or fuse at the electrical disconnect box.
- Good, safe practices and caution MUST be applied when installing, operating, and maintaining any appliance. Follow basic precaution.
- Save these instructions.

- **Before loading** - Before loading the washer, make sure the drum is empty.

About Your Washer-Dryer

■ Your New Appliance

Your new appliance is an automatic washer and condensing* tumble dryer by Splendide. Front-loading with a stainless steel drum and an extra-large door opening for easy loading and unloading, it features 9 wash programs, 6 water temp. settings, 3 dry programs, a delay start option and a 1200 RPM max. spin speed.

■ Features

- **Automatic Dispenser Drawer** - Your washer-dryer has a convenient dispenser drawer that dispenses laundry aids (detergent, bleach, softener) automatically.
- **Delay Start Option** - Your washer-dryer offers a delay start option, allowing you to run your washer at a later time (or during off-peak hours).
- **Auto Water/Energy Control** - Your washer-dryer doesn't need high, medium, or low water level settings for different wash load sizes. It automatically adjusts the amount of water and energy to use for each load.
- **Safety Door Lock** - Your washer-dryer has an automatic door lock feature that engages for the duration of the wash and dry cycles and protects you from opening the door when there is water or high heat and steam within the drum.
- **Express Wash** - Your washer-dryer features Express wash cycles to wash your lightly soiled Cotton Heavy Duty or Permanent Press fabrics in less time.
- **More Rinse Cycles/Extra Rinse** - Most washers have only 1 rinse following each wash while your Splendide washer-dryer has up to 4. It rinses 3 times after every wash (except Express Wash) and features an Extra Rinse button that adds yet another rinse to remove even more dirt/detergent from fabrics (recommended for those with detergent contact allergies).
- **Foam Removal System** - Your machine automatically measures the amount of foam in circulation and adds water to the drum to remove excess foam for the highest rinsing performance.
- **Recirculating Wash Feature** - With your Splendide washer-dryer, no detergent is wasted. Water recirculates and redistributes detergent throughout the drum in a way that assures all detergent is dissolved for max. resource efficiency.
- **Automatic Balance System** - Every Splendide washer-dryer incorporates the latest motor technology Automatic Balance System (ABS). When it detects an out-of-balance load the motor will adjust speed (or come to a complete stop) and reposition the load automatically.
- **Impulse Spin Technology** - Your machine features Splendide's exclusive IST processor that varies pulse in low spin for less wrinkling, less wear on clothing, less noise, less vibration, and improved energy efficiency.
- **Dry Spin** - During Cotton Heavy Duty drying, there is an additional spin for improved drying performance.

Understanding the Control Panel

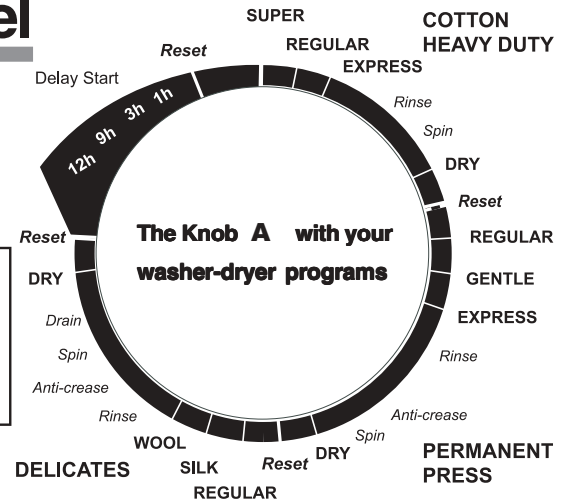
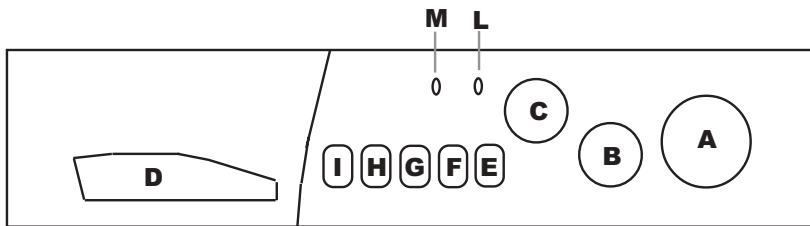

- **Program Selector (Turn clockwise only) (A)** - Use this knob to select one of 9 wash programs (see “Guide to the Wash Programs,” p. 10).
- **Delay Start Option:** You can also use this knob to delay the start of any wash program by 1, 3, 9, or 12 hours (see “How to Wash,” p. 14).



IMPORTANT: Should you wish to interrupt a program in progress or set a new one, advance the Program Selector knob (A) to a “Reset” position and wait 5 seconds.

- **Dry Time Knob (B)** - Use this knob to set the drying time up to 120 minutes. **Once set, this knob will not move.** NOTE: The last 12 minutes of the dry cycle is a cool down period (See “Dryer Cool Down,” p. 7).

- **Water Temperature Knob (C)** - Use this knob to set your wash water temperature. Choose between HOT, WARM, COLD, or variations between. NOTE: Rinse water temperatures are always COLD.

- **Dispenser Drawer (D)** - This is where you add your detergent and other laundry aids (See “How to Use the Dispenser Drawer,” p. 13).

- **Pre-wash Button (E)** - For heavily soiled loads, push this button to add an extra wash to any wash program (except the Wool program or when another Special Program (F, G, H) is selected).

- **Easy Iron Button (Rinse Hold) (F)** - Pressing this button prevents fabric creasing, making items easier to iron. (Only available on Permanent Press cycles and the Silk cycle). If pressed, the wash cycle will come to a complete stop (Rinse Hold) at the “Anti-crease” part of the dial-allowing you to leave items in the machine without spinning to prevent wrinkling. You complete it by pressing the Easy Iron button again. NOTE: If a dry cycle is preset, machine will not perform the anti-crease (rinse hold) function.

- **Low Spin Button (G)** - Press this button to reduce the spinning speed to 600 RPM during any Cotton Heavy Duty or Permanent Press cycle-perfect for washing more delicate fabrics in these cycles.

- **Extra Rinse Button (H)** - Press this button to add an extra rinse cycle to any Cotton Heavy Duty or Permanent Press cycle to improve rinsing results while washing full loads (when more detergent is used). NOTE: Recommended for those who have detergent contact allergies.

- **On/Off Button (I)** - Press this button to turn your washer-dryer ON or OFF. “In” position, machine is ON. “Out” position, machine is OFF. NOTE: Turning the appliance OFF does not cancel selected wash program.

■ Status/Door Lock Lamp (L)

- **Flashes Slowly:** Door can be opened. The appliance is on and awaiting instruction or the cycle has ended.
- **Steady Light:** Door lock is engaged / Program accepted.
- **Flashes quickly:** Program has ended and door lock is engaged. NOTE: Door may remain locked for up to 1-2 min. after end of cycle.

- **Auto Dry Lamp (M)** - Lights when the dry timer has been set and following the wash cycle, the appliance will automatically run the selected tumble drying cycle.

NOTE: Auto dry not available when Silk or Wool cycle is selected.

Guide to the Wash Programs

Type of Fabric and Degree of Soil	Program Knob	Detergent For Wash	Fabric Softener	Bleach	Special Programs Available*	Total Length of cycle	Description of Wash Cycle
Cotton Heavy Duty							
Exceptionally soiled whites/colorfast fabrics (Sheets, tablecloths, etc.)	Super	•	•	•	P, L, R	70 min.	35 min. wash cycle, 3 rinse cycles, intermediate and final spin cycles
Heavily soiled whites/colorfast fabrics	Regular	•	•	•	P, L, R	65 min.	27 min. wash cycle, 3 rinse cycles, intermediate and final spin cycles
Slightly soiled whites and light colors (T-Shirts, sweatshirts, etc.)	Express	•	•	•	P, L, R	35 min.	14 min. wash cycle, 2 rinse cycles, intermediate and final spin cycles
Rinse cycles	Softener is automatically dispensed during the last rinse						Rinse cycles, intermediate and final spin cycles
Spin cycle (1200 RPM high spin)							Draining and final spin cycle
Drying cycle for cotton fabrics							Cotton Heavy Duty Dry Program
Reset							Interrupts/cancels program
Permanent Press							
Heavily soiled colorfast synthetics (Baby linen, etc.)	Regular	•	•		P, E, L, R	60 min.	26 min. wash cycle, 3 rinse cycles, anti-crease or spin cycle
Delicate color synthetics (All types of slightly soiled garments)	Gentle	•	•		P, E, L, R	55 min.	19 min. wash cycle, 3 rinse cycles, anti-crease or spin cycle
Delicate color synthetics (All types of slightly soiled garments)	Express	•	•		P, E, L, R	35 min.	13 min. wash cycle, 2 rinse cycles, anti-crease or spin cycle
Rinse cycles	Softener is automatically dispensed during the last rinse						Rinse cycles, anti-crease or spin cycle
Spin cycle (850 RPM spin)							Draining and spin cycle
Drying cycle for synthetic fabrics							Permanent Press Dry Program
Reset							Interrupts/cancels program
Delicates							
Delicates	Regular	•	•		P	40 min.	16 min. wash cycle, 3 rinse cycles, anti-crease or spin cycle
Silk and particularly delicate garments (Curtains, silk, viscose, etc.)	Silk	•	•		P, E	30 min.	17 min. wash cycle, 3 rinse cycles and draining (no spin cycle)
Wool, hand wash	Wool	•	•			35 min.	27 min. wash cycle, 2 rinse cycles, anti-crease or spin cycle
Rinse cycles	Softener is automatically dispensed during the last rinse						Rinse cycles, anti-crease or draining or spin cycle
Spin cycle (600 RPM spin)							Draining and spin cycle
Draining							Draining Only (Silk program)
Drying cycle for synthetic fabrics							Delicates Dry Program
Reset							Interrupts/cancels program
Delay Start							
12 - 9 - 3 - 1 hour delay							Program start is delayed
Stop/Reset							Interrupts/Cancels program

****Easy Iron Description:**

Wash Only: Reduced agitation, rinse, spin speed and Anti-crease (Rinse Hold).
 Wash to Dry: Reduced agitation, rinse, and dry temp. (No Anti-crease function).

***Special Programs:**

P = Prewash
E = Easy Iron**
L = Low Spin
R = Extra Rinse

Note: Above cycle times vary according to water pressure, load size and fabric type.

Getting Started



"Don't forget to empty all pockets before you load items in your washer-dryer: small objects can cause serious damage to your machine."



"Using fabric softener is very important for optimum performance with automatic wash through dry loads."

Preparing Laundry

■ Sort & Prepare

Before washing, you can do a great deal to ensure better wash results by preparing your laundry correctly. Always read the fabric labels and follow their guidelines. Separate items according to color, fabric type, and degree of soil. Separate items that shed lint from those that attract lint.

- Pre-treat heavily soiled areas.
- Empty Pockets. Fasten all hooks, zippers and buttons. Tie strings, apron sashes, etc. Remove non-washable buckles, trims and belts.
- Turn knit garments inside out.
- Place delicate items such as bras, shoulder pads, underwear, tights and stockings in a mesh laundry pouch to prevent tangling.
- Mend garments that are ripped or torn so that further damage is not done.

■ About Pre-washing

Use your washer-dryers Pre-wash feature when washing excessively soiled clothes that contain deeply embedded dirt such as men's work clothes or children's play clothes.

■ About Pre-treating

Pre-treat heavily soiled areas of clothing with a pre-wash spray, liquid laundry detergent, or a laundry detergent/water paste mixture over the stains before washing (see "Stain Removal Chart," p. 11) for treatment of specific stains.

About Laundry Aids

■ Detergent

Your Splendide requires smaller amounts of laundry aids to get fabrics cleaner. If your previous washer was a top loader, you may not need to add as much (or any) detergent to initial wash loads. Old detergent trapped in fabrics will release during the tumble action wash cycle.

- **Amount:** 1-2 tablespoons of any powder laundry detergent (or liquid equiv.) per wash load. However, if you have access to them, low-sudsing, high efficiency (HE) detergents are designed for use in front-loading machines and are recommended.
- Adjust the amount for heavily or lightly soiled loads. Use more if water is extremely hard - use less in soft water. If garments have been pretreated, you won't need as much (or any) detergent at all.
- Your machine features an internal foam removal system, however, if the suds level rises too high, set the Program Selector knob (A) to "Rinse" and allow the machine to rinse out.



IMPORTANT: The suds level should never rise more than half way up to the porthole. Too much foam will rise through the detergent dispenser and make a mess on your floor!

■ Liquid Fabric Softener

Using fabric softener causes items to release from the drum immediately after your washer-dryer's high-speed spin, helping clothes to dry faster while minimizing wrinkling and softening fabrics.

- **Amount:** 1-2 tablespoons of a bio-friendly, or similar brand per wash load. These softeners tend to appear light in color and dissolve more quickly in less water, minimizing build-up within your machine.
- Adjust the amount for heavily or lightly soiled loads. Use more if water is extremely hard - use less in soft water.



IMPORTANT: Never use softener sheets or exceed the recommended amount of liquid fabric softener. Doing so could impair wash results and cause damage to the internal parts of your machine!

■ Bleach (Cotton Heavy Duty Cycles Only)

Use bleach to whiten, remove certain problem stains, deodorize and even sanitize fabrics.

























WARNING: Always dilute bleach before using. Never overfill bleach dispenser. Excess bleach could damage clothes. Bleach should never be added to rinse water.

Getting Started

Understanding Fabric Care Labels

Garment labels contain washing/drying instructions expressed in small symbols. Learn the symbols on this table; they'll help you to obtain better wash results, treat your clothes properly, and get a better performance from your machine.

Machine Wash Cycle	 Normal/ Cotton Heavy Duty	 Permanent Press/ wrinkle resistant	 Delicate/ Gentle	 Hand wash	 Do not wash	 Do not wring
Water Temp.	 Hot (50°C/120°F)			 Warm (40°C/105°F)		 Cold/Cool (30°C/85°F)
Tumble Dry	 Dry	 Normal/ Cotton Heavy Duty	 Permt Press/ wrinkle resistant	 Delicate/ Gentle	 Do not tumble dry	 Do not dry
Special Instructions	 Line dry/ hang to dry	 Drip dry	 Dry flat	 In the shade	 <p>"Look! Always check the labels on your clothing. They will help you select the right wash program, temperature, laundry aids and more."</p>	
Bleach Symbols	 Any bleach (when needed)	 Only non-chlorine bleach (when needed)	 Do not bleach			

Stain Removal Chart

Always check the care labels before treating a stain, and check the fabric for colorfastness by testing stain remover on an inside seam.

Stain	Treatment
Adhesive tape, chewing gum, rubber cement	Apply ice. Scrape off excess. Place stain face down on paper towels. Saturate with prewash stain remover or nonflammable dry cleaning fluid.
Baby formula, dairy products,	Use product containing enzymes to pretreat or soak stains. Soak for 30 minutes or more. Wash.
Beverages (coffee, tea, soda)	Pretreat stain. Wash using cold water and bleach safe for fabric.
Blood	Rinse w/cold water. Rub w/bar soap or pretreat or soak with product containing enzymes. Wash using fabric safe bleach.
Candle wax, crayon	Scrape off surface wax. Place stain face down between paper towels. Press with warm iron until wax is absorbed. Replace paper towels frequently. Treat remaining stain with prewash stain remover or nonflammable dry cleaning fluid. Hand wash to remove solvent. Wash using bleach safe for fabric.
Chocolate, grass, mustard, tomato	Pretreat or soak in warm water using product containing enzymes. Wash using bleach safe for fabric.
Collar or cuff soil, cosmetics	Pretreat with prewash stain remover or rub with bar of soap.
Dye transfer on white fabric	Use packaged color remover. Wash using bleach safe for fabric.
Grease, oil, tar (butter, fats, salad dressing, cooking oils, car grease, motor oils)	Scrape residue from fabric. Pretreat. Wash using hottest water safe for fabric. For heavy stains and tar, apply nonflammable dry cleaning fluid to back of stain. Replace towels under stain frequently. Rinse THOROUGHLY. Wash using hottest water safe for fabric.
Ink	Some inks may be impossible to remove. Washing may set some inks. Use prewash stain remover, denatured alcohol or nonflammable dry cleaning fluid.
Mildew, scorch	May be impossible. Wash with chlorine bleach if safe for fabric, or soak in oxygen bleach and hot water before washing.
Mud	Brush off dry mud. Pretreat or soak with product containing enzymes.
Nail polish	May be impossible. Place stain face down on paper towels. Apply nail polish remover to back of stain. Repeat, replacing paper towels frequently. Do not use on acetate fabrics.
Paint, varnish	WATER BASED: Rinse fabric in cool water while stain is wet. Wash. Once paint is dry, it cannot be removed. OIL BASED AND VARNISH: Use solvent recommended on can label. Rinse THOROUGHLY before washing.
Perspiration	Use pre-wash stain remover or rub with bar soap. Rinse. Wash using non chlorine bleach in hottest water safe for fabric.
Rust, brown or yellow discoloration	SPOTS: use rust remover safe for fabric. DISCOLORATION OF ENTIRE LOAD: use phosphate detergent and non-chlorine bleach.

Operation Instructions

Choosing a Load

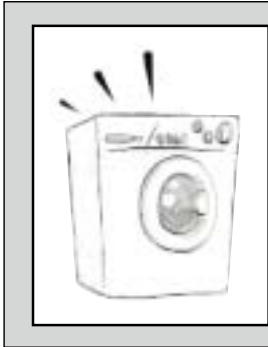

"Remember, while your Splendide may have the largest drum size available on a combination washer-dryer, it's still smaller than a standard top-loading washer.

Loading the drum correctly will reduce dry times and increase washing performance considerably."

■ Is using a combination washer-dryer much different than what I'm use to?

Yes, in some ways. You are washing and drying in the same drum (1.5-1.9 cu.ft.) and load sizes are smaller. Wash cycles are similar, but because combination washer-dryers are compact and operate using 115V (vs. 230V), dry times are longer. Instead of washing several, bulky loads of laundry in one day, you'll learn to adjust your laundry habits to launder smaller, more convenient loads every day or two.

■ Wash Through Dry Loads

Your machine can wash larger loads than it can dry. Remember, separate washers and dryers have drums of different sizes (the washer is half the size of the dryer), and your machine washes and dries in the same drum. Therefore, when you program your machine to wash through dry automatically, you must load the drum according to the maximum recommended load size for drying (see "Load Types/Sizes and Drying Times," below).

NOTE: automatic wash through dry not available when Silk or Wool cycle is selected

■ Load Types/Sizes and Drying Times

Drying times depend largely on the type of material (some fibers absorb more water than others), on the dampness of the articles when drying is started (1200 RPM spin vs. 850 - 600 RPM spin), and on the amount of laundry that is being dried. Jeans, towels and similar (rather thick) articles will take longer to dry.

- For the condensation process to occur, all items must be able to tumble freely in the drum. If you overload the drum, your laundry will not dry. As a rule, if your dry times exceed 110 minutes, you should reduce your load sizes.

Helpful Hints

- ▶ **Combine large and small items in one full load.** When washing single items such as a sweater, towel or jeans, add 1 or 2 similar items to help balance the load. Single, heavy items such as a bathrobe can be washed separately.
- ▶ **Never use your washing machine to wash torn, fraying or non-hemmed linen.** If it's absolutely necessary, place these items in a mesh bag for protection.
- ▶ **Do not wash colored linens with whites.** Do not wash rugs that could come apart and clog your pump.
- ▶ **Colored T-shirts, printed ones and sweatshirts last longer if turned inside out before washing.** Printed T-shirts and sweatshirts should always be ironed inside out.
- ▶ **For more delicate garments** protect underwear, tights, stockings and delicate items by placing them in a mesh laundry pouch while washing and drying.
- ▶ **Dungaree alert!** Overalls have straps with hooks that can damage the drum of your washing machine or other garments during wash. To minimize the risk, place hooks in the pockets and fasten with safety pins.
- ▶ **When using the "Wool" cycle for best results, we recommend that you use a detergent that is for wool garments, taking care not to wash more than 2.2 lbs.**

■ Sample Wash Through Dry Loads

To get you started, here are a few sample load sizes that can go directly from wash through dry. NOTE: Data purely indicative. Actual drying times will vary depending on type/weight of material.

Sample Load 1

- Wash Cycle: Regular Cotton Heavy Duty/ Dry Time: 110 min.
- 2-3 Bath Towels (27" x 52" / all 100% cotton)
- 1 Hand Towel (16" x 28")
- 1-2 Wash Cloth(s) (13" x 13")

Sample Load 2

- Wash Cycle: Regular Cotton Heavy Duty/ Dry Time: 75-110 min.
- 1 Flat Sheet (90" x 102" / all 230 thread count)
- 1 Fitted Sheet (60" x 80")
- 2 Standard Queen Pillowcases (21" x 32")

Sample Load 3

- Wash Cycle: Regular Cotton Heavy Duty / Dry Time: 110 min.
- 1 Hand Towel (16" x 28")
- 1 Pair Jeans (35" waist/32" inseam)
- 1 Sweatshirt (Large, 50% cotton, 50% polyester)

About the Dispenser Drawer

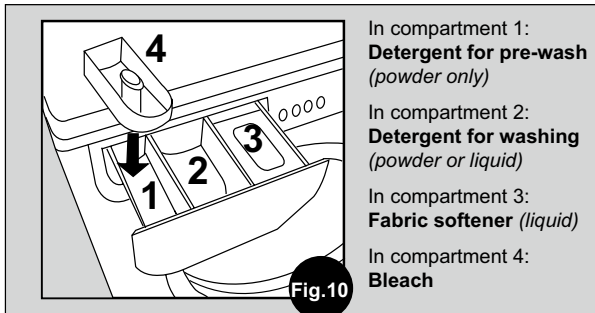

"The dispenser drawer is where you add your detergent and other laundry aids."

■ How to Use the Dispenser Drawer

- Pull out the dispenser drawer to reveal the four compartments. The drawer is divided into 3+1 compartments: one for pre-wash detergent, one for wash detergent, one for fabric softener, and one for bleach (see Fig. 10, for a description of each).
- Add the correct type/amount of detergent, fabric softener, and bleach (if needed) to the corresponding compartments (see "About Laundry Aids," p. 10).
 - When finished, simply close the door. Laundry aids will automatically be flushed into the machine during the wash cycle. *NOTE: From time to time you may see water in the dispenser compartments. This is a result of the siphoning action and is part of the normal operation of the washer.*



IMPORTANT: Do not exceed the recommended amounts (p. 10). Using too much detergent and softener causes over-sudsing and poor rinsing and will harm the efficiency of your condenser. Only use detergents that are suitable for washing machines.

Helpful Hints

- ▶ **Before adding detergent for pre-washing** in the Pre-wash compartment (1), make sure that the extra compartment for bleach has not been inserted. Do not use liquid detergent in the pre-wash compartment. The pre-wash compartment only accepts powder detergent.
- ▶ **When you use fabric softener**, the washing machine automatically dispenses the softener to the last rinse of your selected wash program.
- ▶ **When using liquid detergent**, pour the detergent into compartment 2 just a few seconds before starting the wash cycle.
- ▶ **Never use hand-washing detergent**, because it may form too much foam and could damage your machine.
- ▶ **When washing with cold water**, reduce the amount of detergent you use: it dissolves less easily in cold water than in hot water, so part of it would be wasted.

■ Using Bleach

If bleaching is necessary, the extra compartment (4) must be inserted into the Pre-wash compartment (1) (Fig. 10).

- Be careful not to exceed the "max" level indicated on the central pivot (Fig. 11).
 - Always dilute the bleach with water before using.
 - Traditional bleach should only be used on sturdy white fabrics; therefore, the bleach option is only available when using a Cotton Heavy Duty cycle.
- NOTES: the use of the additional bleach compartment excludes the possibility of using the Pre-wash button.*

When using Bleach it is recommended that you press the Extra-rinse button.



■ Detergent Dispenser Cleansing

Occasionally, detergent build up may accumulate in and/or around your dispenser drawer. The detergent dispenser can easily be removed and cleaned:

- Pull it outwards (Fig. 11b).
- Leave it under running water a few minutes to remove the build up.
- Inspect and wipe out dispenser alcove if necessary. Replace the dispenser drawer.



How to Wash

■ Starting Your Washer-Dryer

Starting your washer-dryer in the right way effects the quality of your wash results, will help prevent future problems, and will enhance the life expectancy of your machine. Once you have loaded your washer-dryer correctly (see “Choosing a Load,” p. 12) and added detergent and fabric softener (see “About Laundry Aids” on p. 10), always check that:

- The door is closed correctly;
- The plug is secured in the socket;
- The water supply is turned on;
- The Program Selector Knob (A) is positioned on one of the “Reset” positions;
- The On/Off button (I) is in the OFF position.

■ How to Wash Only

Select the program according to the type of garments you are washing. Refer to the “Guide to the Wash Programs” chart on p. 7 then:

- Turn the Program Selector knob (A) clockwise until the selected program is aligned with the mark on the knob.
- Turn the Wash Temp. knob (C) to the desired wash temperature for your load.
- If necessary, use buttons E, F, G, or H to run a Special Program. If you do not wish to use these buttons, leave them in their OFF (OUT) position.
- Lastly, press the On/Off button (I) in. The Status/Door Lock lamp (L) will flash slowly for 5 seconds, then will light steady to indicate that the program has been accepted. *NOTE: Should you wish to interrupt a program in progress or set a new one, advance the Program Selector knob (A) to a “Reset” position and wait 5 seconds. Pilot lamp (L) will flash slowly, then turn the appliance off.*

At the end of the wash cycle:

- The Status/Door Lock lamp (L) will flash quickly for up to 1-2 min. to indicate that the cycle is finished, but the door is still locked. The light will flash slowly when the door can safely be opened.
- When the Status/Door Lock lamp (L) light flashes slowly, turn the washer-dryer OFF by pressing the On/Off button (I) again.
- Open the washer-dryer door and remove your freshly cleaned laundry.
- After removing your laundry, leave the door open to allow for air circulation inside the drum to avoid the formation of bad odors.

Helpful Hints

- ▶ **To eliminate worry about selecting the right water level**, your washer has a sensor water level control system that is designed to ensure the correct amount of water is pumped into the machine for any load size.
- ▶ **Use one of the “Express” wash cycles** to wash smaller loads of your lightly soiled Cotton Heavy Duty or Permanent Press fabrics in less time.
- ▶ **About the Easy Iron button:** This special program uses specifically studied wash motions to respect fabrics in the best possible way. During the rinse phase, it introduces more water and the spin cycle is shorter with a reduced spin speed, thus producing more outstretched fabrics for easier ironing (see “Understanding the Control Panel,” pg. 9, for complete instructions).

■ Setting Delay Start

Use the Delay Start option on your washer-dryer to delay the start of any wash program by 12, 9, 3, or 1 hour(s).

- With the machine power OFF, turn the Program Selector Knob (A) clockwise to one of the 4 delay start positions (12, 9, 3, or 1 hr.).
- Press the On/Off button (I). The Status/Door Lock lamp (L) will flash slowly for 5 seconds and then stays lit to indicate that the delay time has been accepted. Now you can turn the knob clockwise to the program you desire.
- The Status/Door Lock lamp (L) has a particular flashing motion (2 seconds on and 4 seconds off) to indicate that a delayed start has been set. During this phase, you can open the appliance door and change the washing load, should you wish to do so. *NOTE: After the wash cycle has been set and accepted by the washer-dryer, turning the knob will have no effect (except when it's on the “Reset” position).*



“But where did all the water go?”

“Simple, Splendide washer-dryers use the newest technology and need less than half the water to get wash results that are twice as good! This is why you cannot see the water through the door.”

Operation Instructions

How to Dry



A Special Note About Condenser Drying:

"When you remove items from your dryer, they may feel hot and humid to the touch. This is a normal result of your machine's self-condensing drying process. Simply shake them out and allow the humidity to dissipate (this only takes a few seconds) then fold or hang them immediately to minimize wrinkling."

■ How to Dry Only

Once you have loaded the drum with the laundry that needs drying, (see "Load Types/Sizes and Dry Times," p. 12) make sure that:

- The door is closed correctly; The plug is secured in the socket; The water supply is turned on; The On/Off button (I) is in the OFF (OUT) position.
- Depending on the type of fabric being dried, turn the Program Selector knob (A) clockwise until one of the three "Dry" programs is aligned with the mark on the knob.



A spin cycle is carried out during drying if you select the Cotton Heavy Duty dry program. For cotton loads of less than 2.2 lbs., use the drying program for Permanent Press fabrics.

- Set the Dry Time knob (C) to the desired dry time.
- Press the On/Off button (I) to turn the machine ON. The Status/Door Lock lamp (L) will flash slowly for 5 seconds, then will light steady to indicate that the program has been accepted.

At the end of the drying cycle:

- The Status/Door Lock lamp (L) will flash quickly for up to 90 seconds to indicate that the cycle is finished, but the door is still locked.
- When the Status/Door Lock lamp (L) light flashes slowly, turn the washer-dryer OFF by pressing the On/Off button (I).
- Open the door and remove your laundry (See "A Special Note About Condenser Drying," above on this page).
- After removing your laundry, leave the door open to allow for air circulation inside the drum to avoid the formation of bad odors.

Warning:

- During the drying phase, the door tends to get quite hot. Do not attempt to open the door when the door lock is engaged.
- Do not use the appliance to dry clothes that have been washed with flammable or chemical solvents (e.g. trichlorethylene).
- This appliance can only be used to dry clothes that have been pre-washed in water.
- Do not use the appliance to dry foam rubber or similar materials.

■ How to Wash & Dry Automatically

If you want your load to go automatically from wash to dry:

- Load the drum according to the recommended maximum load sizes for drying. (See "Wash Through Dry Loads," p. 12).



To protect your delicate fabrics, this machine will not allow a dry program to be set when the Silk or Wool program is selected.



IMPORTANT: To optimize the performance of your machine when going from wash to dry automatically, always use fabric softener during the wash cycle ("About Laundry Aids," p. 10).

- Simply follow the instructions for wash only (see "How to Wash," p. 15) and set the Dry Time knob (C) before pressing the On/Off button (I). Refer to the "How to Dry Only," section on this page.
- The Auto Dry lamp (M) will light to indicate that the dry timer has been set and at the end of the wash cycle, the appliance will run the selected tumble drying cycle.

If the laundry load to be washed and dried is too large to dry, then follow the instructions for wash only (see "How to Wash," p. 14). When the wash cycle has finished, you'll need to remove some items (up to 50%) after the wash cycle to give the remaining ones room to tumble freely while drying. Now follow the instructions for dry only (see "How to Dry Only," this page). Repeat this procedure for the remainder of the load.

Opening the door during the dry cycle: For your safety, the door lock stays engaged for the duration of the dry cycle (see "Features," p. 7). However, should you wish to open the door during the drying cycle, you have two options:

- You can cancel the program by advancing the Program Selector knob (A) to a "Reset" position and waiting 5 seconds. Pilot lamp (L) will flash quickly, then slowly when the door lock is released. Now, turn the appliance off and open the door. When finished, close the door and follow instructions for dry only ("How to Dry Only," this page).
- Or, press the On/Off button (I) to turn the appliance off. Wait 1-2 min. for the door lock to release, then open the door. When finished, close the door and press the On/Off button again. The dryer will automatically resume the selected program where it left off.

Regular Maintenance



"It's Easy! With just a bit of care, your washer-dryer will repay you with loyalty and devotion. With the necessary upkeep, it will give you excellent washing and drying results for years to come."

■ Cleaning the exterior:

The exterior of your machine should be cleaned with a rag dipped in lukewarm water and soap. Do not use polish of any kind on the plastic trim. Some polishes contain agents, which may damage plastics.

■ Cleaning the Interior:

If you live in an area where phosphate detergents are banned, it may be necessary to recondition the washer periodically. If a non-phosphate detergent must be used, body oils and detergent may accumulate in the washer tub. This is particularly evident in hard water areas or homes where heavily soiled garments are regularly laundered. To remove this buildup, run the washer through a complete cycle using HOT water and 2 cups of a non-precipitating water conditioner. Do not add any clothes, laundry detergent, or other laundry aids. Once all the accumulation has been removed, your laundry should be satisfactory if you follow the preventative suggestions in this book.

- Qualified service personnel should clean the interior of the machine periodically.

Helpful Hints

- ▶ **Clean the exterior and rubber parts** of the appliance gently with a soft cloth dipped in warm, soapy water. Never use solvents or abrasives to clean the external or rubber parts of the washer-dryer.
- ▶ **Vacations, or anytime the machine is not in use**, it is recommended that you unplug the machine from the socket and turn off the water supply to limit wear to the machines' water circuit and to eliminate the risk of leakage. Also, leave the door ajar to allow for air circulation within the drum and door gasket area. This will prevent unpleasant odors.
- ▶ **Don't neglect the detergent dispenser.** The detergent dispenser is removable and can easily be cleaned under running water (see "Detergent Dispenser Cleansing," p. 13).
- ▶ **Never leave the washer-dryer plugged in while cleaning.** During cleaning and maintenance the appliance should always be unplugged.

■ General Maintenance:

Your washer-dryer is designed to provide reliable service over many years. A few simple steps will help to prolong its life and avoid problems:

- After washing is complete, the water faucets should be turned off to relieve water pressure on the hoses.
- Before moving you washer-dryer to a new location, you must reattach the transit screws/spacers you removed during installation (p. 5).
- Wipe the inside of the washer-dryer door with a soft cloth to remove any remaining moisture after washing. Periodically, a thin coat of paste wax should be applied to the inner door of the washer, especially to the area that is immediately next to the porthole window. This will protect the door finish from laundry aid spills and any discoloration that could result from these spills.
- Clear the pump pre-chamber if it gets clogged. See "When Needed, Check the Pump," p. 17).
- The use of a de-liming product is recommended every wash ONLY if the water is particularly hard or rich in lime content. Normal detergents already contain de-liming agents. A periodical wash cycle with a dose of a de-liming product (without detergents or laundry) may prove useful.
- Never use too much detergent or additives, because this could cause an excessive amount of foam, increasing the potential for damage to the component parts of your washer-dryer. See "About Laundry Aids," (p. 10).
- It is important to wash the detergent dispenser drawer regularly. If dried laundry aids accumulate, place the dispenser under running water for a few minutes until clean. See "Detergent Dispenser Cleansing," (p. 13).

Continued on next page

Monthly/Yearly Maint.

■ Winterizing Your Machine

If needed, follow these steps to winterize your machine:

- With the machine power OFF, put 1/2 quart of R.V.-type antifreeze in the drum. Close the door.
- Turn the Program Selector knob to Spin. Turn the power On. Let the machine spin for 1-2 min.
- Turn the power OFF. Unplug the washer or disconnect power.
- Shut off both water faucets. Disconnect water inlet hoses from faucets and drain. DONE!

To Use Again:

- Flush water pipes.
- Reconnect water inlet hoses to the corresponding HOT and COLD faucets. Turn on both water faucets.
- Plug in washer or reconnect power.
- Run the washer through the Express cycle with 1/2 tablespoon of powder detergent (or liquid equiv.) to clean out antifreeze. DONE!

■ Optional RV Winterization:

If currently pumping antifreeze through the fresh water system, follow these steps to winterize your machine:

- With the machine power OFF, turn the Wash Temp. knob to WARM.
- Turn the Program Selector knob to Regular wash (located in the Cotton Heavy Duty section of the dial.) Turn the power ON.
- When you see antifreeze in the drum, turn the power OFF. Now advance the Program Selector knob to Spin.
- Turn the power ON. Allow the drum to spin for 30 seconds.
- Turn the power OFF. DONE!

■ Check the Water Inlet Hoses

Periodically inspect and replace hoses if bulges, kinks, cuts, wear, or leaks are found. Remove and clean the filters and the water valves (Fig. 12). Replace inlet hoses as needed to reduce the risk of hose failure.



IMPORTANT: Replace inlet hoses at least every five years of use to reduce the risk of hose failure. Inspect and replace inlet hoses if bulges, kinks, cuts or leaks are found. NOTE: When replacing your inlet hoses, mark the date of replacement on the label with a permanent marker.

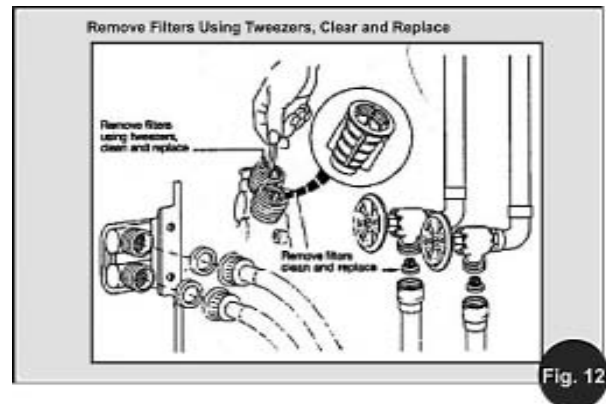

■ When Needed, Check the Pump

Your washer-dryer comes equipped with a self-cleaning pump that does not require regular cleaning and maintenance. However, small objects may accidentally fall into the pump: coins, hair clips, loose buttons and other small items. To avoid possible damage, they are withheld in an accessible pre-chamber at the lower end of the pump.







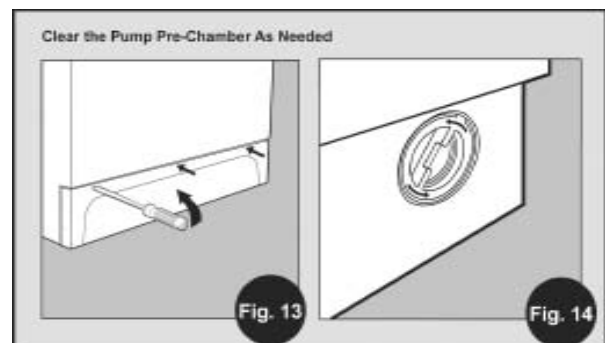

IMPORTANT: Before attempting to examine this pre-chamber, first ensure that the machine has finished its program and is empty. As with any maintenance, unplug the machine.

- To gain access, gently ease down the top of the toe-kick panel (at the base of the front of the machine) with a screwdriver or similar item to release it. Then ease the top edge forward to allow it to be lifted clear (Fig. 13).
- Place a shallow dish or tray below the cover of the pre-chamber to catch the small amount of water present. Release the cover by turning counter-clockwise (Fig. 14). Remove any items or debris.
- Securely replace the cover by turning clockwise. Refit the toe-kick panel by inserting the hooks on its lower edge into the slots and ease the top edge back into position.

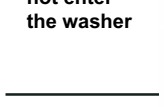

Avoid Service Checklist

In most cases, when your washer-dryer fails to work, the problems arising can be easily solved without having to call for a technician. Before calling for assistance, always check these points:

Operation	Possible Cause	What to do
The washer does not start 	<p><i>There is no power.</i></p> <p><i>Door is open.</i></p> <p><i>The Delay Start has been programmed (p. 14).</i></p> <p><i>Controls not set properly (p. 14).</i></p> <p><i>Water supply is turned off or the supply hoses are kinked.</i></p>	<p>Check that the plug has been correctly inserted into the socket and that there is electricity to the plug. Check house circuit breakers/fuses. Replace fuses or reset breaker. Washer should have separate outlet.</p> <p>Close the door.</p> <p>Move the program selector knob (A) to one of the Reset positions to cancel the program. Then reset the controls without setting the delay start.</p> <p>Refer to the "How to Wash" section (p. 14) to make sure your controls are set correctly.</p> <p>Turn both hot and cold faucets fully ON. Make sure hoses are not kinked or pinched.</p>
The machine continuously fills and drains water 	<p><i>Wall drainage system doesn't have a breather pipe.</i></p> <p><i>Drain hose is positioned too low causing siphoning (Fig. 6, p. 5).</i></p>	<p>Make sure that the wall drainage system has a breather pipe. If you live on an upper floor of your building, there may be a problem with your drain trap. To solve this problem, a special valve must be installed.</p> <p>Check that the standpipe is at least 25" high and not more than 34" high. Make sure that no more than 6" of drain hose is inserted into the standpipe. If the problem still persists after these checks, turn the water supply OFF and call for assistance.</p>
Water does not enter the washer 	<p><i>Hose is not connected correctly to the tap (p. 4).</i></p> <p><i>Water supply is not adequate (p. 2).</i></p> <p><i>Water inlet hoses are kinked or clogged.</i></p>	<p>Review the installation instructions and make sure the hoses are connected properly to the tap.</p> <p>Check water pressure. The water heater may be malfunctioning. Water may be being used elsewhere in your home. Make sure that the hot and cold water inlet faucets are turned fully ON.</p> <p>Free the inlet hoses of any kinks and clear them of any clogs. If the water is very calcareous, or if work has recently been carried out on the water piping, the tap filter could be clogged with particles and debris.</p>
The program selector knob keeps turning 	<p><i>The machine needs to be Reset.</i></p>	<p>Wait a few minutes for the drain pump to empty the tub, switch the washer-dryer OFF. Select one of the Reset positions on the knob, then switch it back ON. If the knob continues to turn, call for assistance.</p>
The washer-dryer doesn't drain or spin 	<p><i>The selected program incorporates a manual draining command (p. 8).</i></p> <p><i>The drain pump is clogged (p. 17).</i></p> <p><i>The drain hose is kinked or clogged.</i></p>	<p>When using the Easy Iron function without presetting a drying program, the machine will stop and wait for your command to drain. Simply press the Easy Iron button again and the machine will drain.</p> <p>Turn the water supply OFF, unplug the washer-dryer and follow the "When Needed, Check the Pump" instructions (p. 17) to unclog the pump.</p> <p>Make sure that the drain hose is not squashed or kinked. The drain hose should be as straight as possible. Check that nothing is blocking the water flow.</p>
The washer produces too much foam 	<p><i>The detergent used is not suitable for washing machines.</i></p> <p><i>Too much detergent or softener is being used (p. 10).</i></p>	<p>Check that the detergent you are using is labeled "For Machine Wash" or "Hand and Machine Wash" or any similar wording.</p> <p>Make sure that you are using only 1-2 tablespoons of low-sudsing powdered detergent (or liquid equiv.) and 1-2 tbsp. of softener per wash load.</p>
Excessive vibration during the spin cycle 	<p><i>The transit screws and spacers are still installed (p. 4).</i></p> <p><i>The washer-dryer is not leveled correctly (p. 5).</i></p> <p><i>Overloading (p. 12).</i></p>	<p>Make sure that the transit screws and spacers are removed.</p> <p>The level of the washer-dryer should be checked periodically. Adjust the feet and check the machine with a level.</p> <p>Make sure the drum is not overloaded.</p>
The washer-dryer leaks 	<p><i>The inlet hose is not properly attached (p. 4).</i></p> <p><i>The machine is not level (p. 5).</i></p> <p><i>The detergent dispenser is obstructed (p. 13).</i></p> <p><i>The drain hose is not positioned properly (p. 4).</i></p> <p><i>The drain pump is obstructed (p. 17).</i></p>	<p>Turn off the water supply, unplug the appliance and refer to the "Connecting the Water Inlet" section (p. 4) to tighten the attachment.</p> <p>Make sure the machine is resting level on a level surface.</p> <p>Remove the dispenser drawer and wash it under tap water to remove any detergent residue that has built up.</p> <p>Turn off the water supply, unplug the appliance, and position the drain hose correctly. Refer to the "Water Drainage" section (p. 4).</p> <p>Follow the "When Needed, Check the Pump" directions (p. 18) to remove any debris from the pumps pre-chamber.</p>

Continued on next page

Troubleshooting

Operation	Possible Cause	What to Do
The dryer does not start	<p><i>There is no power.</i></p> <p><i>The door is open.</i></p> <p><i>The Delay Start has been programmed (p. 14).</i></p> <p><i>Water supply turned off, kinked.</i></p> <p><i>The controls are not set properly (p. 15).</i></p>	<p>Check that the plug has been correctly inserted into the socket and that there is electricity to the plug. Check house circuit breakers/fuses. Replace fuses or reset breaker. Washer should have separate outlet.</p> <p>Close the door.</p> <p>Move the program selector knob (A) to one of the Reset positions to cancel the program. Then reset the controls without setting the delay start.</p> <p>Turn both hot and cold faucets fully ON. Make sure hoses are not kinked or pinched.</p> <p>Make sure that the program selector knob (A) is set to a Dry position and that the Dry Time knob (C) is set to your desired dry time.</p>
The dryer does not dry properly	<p><i>End of drain hose is under water.</i></p> <p><i>The drain pump is obstructed. (p. 17)</i></p> <p><i>The drum has been overloaded (p. 12).</i></p> <p><i>The cold water tap is turned OFF.</i></p>	<p>Make sure that the drain hose is positioned properly (p. 5).</p> <p>Follow the "When Needed, Check the Pump" directions (p. 17) to remove any debris from the pumps pre-chamber.</p> <p>Follow the "Choosing A Load" (p. 12) instructions in this manual for recommended load sizes for drying.</p> <p>Turn the cold water tap ON. Cold water is essential to your machine's condensing drying process.</p>
Dryer performance has decreased over time	<p><i>Continual oversudsing from using too much/wrong kind of laundry aids (p. 10).</i></p>	<p>Always use the correct amount of fabric softener and low-sudsing detergent. Over time, continual over-sudsing can clog up the condensing chamber and fan blower with lint particles and reduce drying efficiency. If needed, an internal condenser cleaning kit is available from Splendide for purchase with instructions. <i>NOTE: The interior of the machine should be cleaned periodically by a qualified service technician.</i></p>
Lint or residue on clothing	<p><i>Washing is too long.</i></p> <p><i>Detergent not dissolving.</i></p> <p><i>Overloading (p. 12).</i></p>	<p>Excess wash time may create lint. Select a shorter wash cycle (p. 9).</p> <p>Try a liquid detergent and/or use a warmer temperature setting.</p> <p>Make sure the drum is not overloaded. For wash loads, you should be able to close the door easily; items should not be tightly packed.</p>
Stains on the load	<p><i>A fabric softener dispensing ball was used.</i></p> <p><i>Powdered detergent in low spin.</i></p> <p><i>Large load in Express wash.</i></p> <p><i>Incorrect sorting (p. 10).</i></p> <p><i>Overloading (p. 12).</i></p>	<p>Dispensing balls will not operate correctly in this machine. Add liquid fabric softener to the fabric softener compartment.</p> <p>Consider using liquid detergent in wash cycles with low spin.</p> <p>For best results, use Express wash for small, lightly soiled loads.</p> <p>Avoid mixing heavy fabrics with light fabrics.</p> <p>Load your dryer so clothes have enough room to move freely in the drum while drying.</p>
Wrinkling	<p><i>Incorrect wash cycle (p. 9).</i></p> <p><i>Clothes matted to drum after Spin (p. 10).</i></p>	<p>Match cycle selection to type of fabric you are using. Repeated washing in water that is too hot may cause wrinkling.</p> <p>Use the recommended amount of fabric softener during the wash cycle.</p>

If You Need Service

Every Splendide washer-dryer comes with a Limited Warranty. Please read the Limited Warranty Statement that came separately with your machine for complete details. You'll find many answers to common problems in the "Avoid Service Checklist" section of this manual. If you review this section first, you may not need to call for service at all. *NOTE: You will be charged for a service call while the appliance is under warranty if the problems are not caused by defective workmanship or materials.*

- If you do need service, you can relax knowing that help is only a phone call away. Call our Splendide Technical Service/Assistance Department toll-free at 1-800-356-0766 Monday-Friday 8:00AM-5:00PM Pacific Time.
- Please have the model number and serial number of your washer-dryer ready when you call.

"Knowledgeable Splendide Service Technicians are just a phone call away!"



Splendide

Splendide Division Westland Sales
15650 SE 102nd Ave (PO Box 427)
Clackamas, OR 97015 - USA

Phone: 1-800-356-0766
Email: splendide@westlandsales.com
Fax: 503-656-8829
Web: www.splendide.com